



# HALM

## Circulation pumps

Wet rotor circulators and accessories

Heating  
Potable water  
Solar  
Geothermy  
Condensate





## Halm produces highly-efficient heating circulation pumps

Halm has been successfully developing and producing heating circulation pumps for over 30 years. It started out manufacturing for renowned OEM customers before electing to develop and produce its own product range in the late 1990s.

Its proficiency in the development of innovative, market-oriented products is first and foremost reflected in the more than half a century of company history. Today, in the third generation, the circulation pumps segment plays a major part in the success of the company. This is particularly evident in the high level of creative innovation in recent years, with many new products in the field of high-efficiency pumps.

## Halm places great demand on the quality of its products

Modern production facilities and processes are just as much part of the corporate concept as well thought-out quality management. Internal testing facilities and ISO-certified quality management are indispensable factors of success.

Long-standing customers value the high demands placed on the quality of the products and the flexibility with which Halm meets custom requirements.

## Halm is helping to shape the future as a reliable partner

A company is only as good as each of its constituent parts. This is why motivated and experienced employees are a key element of success at Halm. Flexibility and expertise head the list of priorities for being a reliable partner to our customers.

Together with over 230 employees, Halm's objective is to make a lasting contribution to the future with its products. Halm high efficiency pumps already fulfil the tightened requirements of the eco-design directive from 2011 until 2020.

The new HEP Optimo features an LED display showing the modes of operation, the pressure head, the total electrical input power as well as error codes. As standard, it is delivered with a plug and with installation length 180 mm also the insulation shell is included in delivery. No insulation shell is offered for 130mm installation length.

For the HEP Optimo Basic version, we omit features such as display, insulation shell and plug – but we fit a pre-mounted cable in order to be able to offer a very well-priced model for different applications for which these features are neither required nor necessary.



## Catalogue valid for EU countries + others<sup>1)</sup>

<b>I. Product range</b>		<b>Page</b>
<b>Contact</b>		4
<b>General information</b>		5
<b>Heating</b>		
HEP Optimo:	High efficiency pumps with LED display, electronically controlled	6
HEP Optimo Basic:	High efficiency pumps, electronically controlled	8
HEP Optimo L:	High efficiency pumps with LCD display, electronically controlled	10
<b>Potable water</b>		
HEP Optimo (N):	High efficiency pumps with LED display and stainless steel housing, electronically controlled	12
HEP Optimo Basic (N):	High efficiency pumps with stainless steel housing, electronically controlled	14
BUPA (N):	Standard circulation pumps for potable water with stainless steel housing	16
BGPA (N):	Circulation pumps for potable water, with stainless steel housing, pressure head 7-12 m	18
<b>Solar</b>		
HEP Optimo Solar:	High efficiency pumps with LED display, electronically controlled	20
HEP Optimo L Solar:	High efficiency pumps with LCD display, electronically controlled	22
HEP BB2:	Babelbox BB2 and HEP PWM	24
<b>Geothermy</b>		
HEP Optimo Geo:	High efficiency pumps with LED display, electronically controlled and protected against condensation	26
HEP Optimo L Geo:	High efficiency pumps with LCD display, electronically controlled and protected against condensation	28
<b>Condensate</b>		
Lift:	Condensate pump for gas condensing boilers up to 400 kW	30
Lift Basic:	Condensate pump for gas condensing boilers up to 300 kW	31
Lift NT25:	Condensate pump for oil condensing boilers with neutralization tank	32
<b>Accessories</b>		
Screw connections		34
Plug		34
Insulation shell		34
Accessories/Spare parts		35

<sup>1)</sup> EFTA (Iceland, Liechtenstein, Norway), Croatia, Switzerland, autonomic areas of EU member states (Faroe Islands, Jersey, Isle of Man, Guernsey, Greenland), Andorra, Monaco, San Marino.

Subject to technical changes without notice. Errors and omissions excepted.

The latest versions of our sales, delivery, and payment conditions as well as guarantee terms can be found on the internet at [www.halm-pumps.de](http://www.halm-pumps.de)

## Contact at Halm:

---

### Sales

**Mr Robin Pomreinke**

E-mail: robin.pomreinke@halm.info

Phone: +49 7153 9202-32

Fax: +49 7153 9202-45

### Order Management

**Ms Sabrina Wagner**

E-mail: sabrina.wagner@halm.info

Phone: +49 7153 9202-66

Fax: +49 7153 49168

### After Sales

**Mr Jürgen Albrecht**

E-mail: juergen.albrecht@halm.info

Phone: +49 7153 9202-28

Fax: +49 7153 9202-45

**Mr Thomas Müller**

E-mail: thomas.mueller@halm.info

Phone: +49 7153 9202-31

Fax: +49 7153 49168

**Service hotline**

Phone: +49 7153 9202-621

## Halm type key

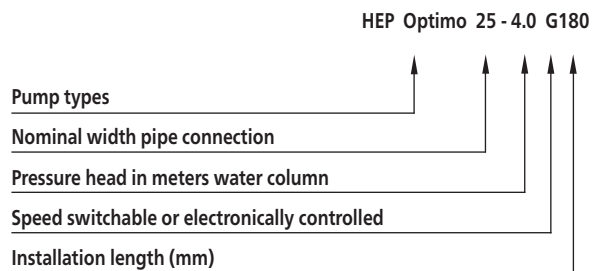

## Installation options

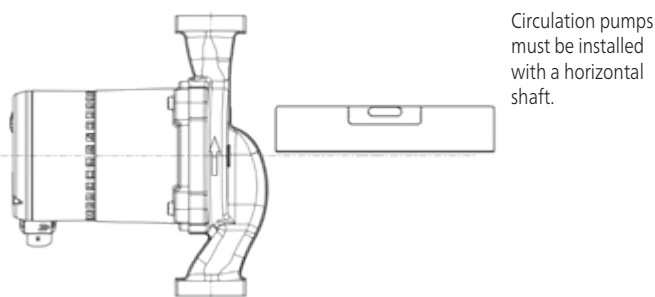

## Construction

Halm circulation pumps are inline wet rotor circulators. They are maintenance-free and fitted with opposite-facing connecting nozzles of the same nominal width. The pump, motor and terminal box comprise one unit and are optimally matched with one another.

A stainless steel can separates the rotor chamber and stator winding. It features static seals at both ends.

## Bearing

Both bearings are made of oxide ceramic. This is particularly suitable because of its hardness, surface quality and corrosion resistance. They ensure smooth running and a long service life. Air cavities in the can well are evacuated via the hollow shaft.

## EEI

The benchmark of the most efficient circulators is  $EEI \leq 0.20$ .

## BEST in class

All Halm 4 m high efficiency pumps fulfill the requirements for BEST in class.



# High efficiency pumps with LED display, electronically controlled

## HEP Optimo series, H1 product group



**Insulation shell**  
With installation length  
180 mm included  
in delivery.

**BEST  
in class**

valid for all Halm 4 m  
High efficiency pumps



### Technical data

Rate of flow:	up to 3.2 m <sup>3</sup> /h
Pressure head:	4 m/6 m/7 m
Control range:	4-23 W/4-50 W/4-66 W
Media temperature:	+2 °C to +95 °C
Installation length:	130 and 180 mm
Threaded connection:	1", 1½" and 2"
Protection class:	IP 42
Insulation class:	F
Nominal pressure:	PN 10
Control:	Δpc + Δpv + fixed rpm
EEL:	≤ 0.20 HEP Optimo XX-4.0 GXXX ≤ 0.23 HEP Optimo XX-6.0 GXXX ≤ 0.23 HEP Optimo XX-7.0 GXXX

### Product features

- manual start-up feature
- smooth running
- very low energy consumption
- integrated night economy feature
- air-vent screw
- LED display
- convenient operation
- space-saving axially integrated terminal box
- automatic adjustment to pressure conditions
- cataphoretic coated pump housing
- pre-mounted, screwable angle entry-plug
- compact design

### Use

The electronically controlled HEP Optimo high efficiency wet rotor circulators with LED display and permanent magnet technology are designed for use in heating systems with variable or constant rate of flow. The cataphoretic coated pump housing is stainless.

### Mode of operation Δp control

When thermostatic valves in systems with a long main supply heating pipe (likely for radiator systems) close, the total flow drops. This results in lower pipe resistance in this main pipe, which means the pump has to create lower head. Using proportional pressure mode PP (L) is the best setting for such heating systems, as here the pump decreases head at lower flow.

If the main supply heating pipe has not to be taken into consideration, because it is short or has its own pump (likely for underfloor heating systems with in mixing units integrated pumps), best mode to go with is constant pressure mode CP (C). In such heating systems, it is important always to have constant pressure for the radiators or ufh-circuits, as the pressure loss in the main pipe is not considered and all other consumers are installed in parallel, which does not influence the maximum pressure loss.

### Main areas of use

Heating, air-conditioning and industry systems as

- dual pipe system
- underfloor heating
- boiler/primary circuit
- storage charging circuit
- solar systems and heating pumps

### Materials

Component	Material	Material no.
Pump housing	Grey-cast iron	0.6020
Impeller	Polyamide (PA - GF 35)	
Shaft	Ceramic	
Bearing	Ceramic	
Bearing plate	Stainless steel	1.4301
Can	Stainless steel	1.4301

### Flow media

- heating water as per VDI 2035
- pure, thin, non-aggressive and non-explosive, mineral oil-free media without solid or long-fibre components
- media with a max. viscosity of 10 mm<sup>2</sup>/s
- operating data must be checked above 20 % glycol

### Temperature range

Ambient temperature:	0 °C to +40 °C
Temperature class:	TF 95
Media temperature:	+2 °C to +95 °C

### Ambient temperature

To avoid condensation forming in the terminal box and stator, the media temperature must always be the same or higher than the ambient temperature.

Ambient temp.	Media temp. min.	Media temp. max.
0	2	95
10	10	95
20	20	95
30	30	95
35	35	90
40	40	70

### Motor protection

External motor protection is not required.

### Integrated night economy feature

When the automatic night economy feature is activated, the circulation pump switches between normal mode and economy mode (characteristic curve MIN). The flow temperature is detected by a temperature sensor, the pump reacts accordingly. For this, it is necessary for the circulation pump to be installed in flow.

### Minimum inflow pressure

Please determine the minimum inflow pressure for corresponding temperature from the following table.

Media temperature	< 75 °C	> 90 °C
Minimum inflow pressure	0.05 bar	0.28 bar

### Sound pressure level

The sound pressure level is < 45 dB (A)

### Choice of control characteristic

You can set 3 different control modes via the potentiometer on the axial terminal box. Proportional pressure (L), fixed speed (M) and constant pressure (C) can be adjusted continuously variable. The display indicates power consumption in [W] watts. Once the potentiometer is turned, the display first indicates mode of operation (PP, SC, CP), then value of set head in [m] meters. At the factory setting the potentiometer is in mode PP.



# High efficiency pumps with LED display, electronically controlled

HEP Optimo series, H1 product group



## Technical data

Type	Connection pipe	Threaded connection	Installation length (mm)	Voltage (V)	P1 (W)	In (A)	Weight (kg)	Product no.	EEl
HEP Optimo 25-4.0 G180	1"	1½"	180	230	4 ... 23	... 0.30	2.7	0323-34204.1	≤ 0.20
HEP Optimo 25-6.0 G180	1"	1½"	180	230	4 ... 50	... 0.46	2.7	0323-34206.1	≤ 0.23
HEP Optimo 25-7.0 G180	1"	1½"	180	230	4 ... 64	... 0.60	2.8	0323-34207.1	≤ 0.23
HEP Optimo 30-4.0 G180	1¼"	2"	180	230	4 ... 23	... 0.30	2.8	0324-34204.1	≤ 0.20
HEP Optimo 30-6.0 G180	1¼"	2"	180	230	4 ... 50	... 0.46	2.8	0324-34206.1	≤ 0.23
HEP Optimo 30-7.0 G180	1¼"	2"	180	230	4 ... 64	... 0.60	2.8	0324-34207.1	≤ 0.23
HEP Optimo 15-4.0 G130	½"	1"	130	230	4 ... 23	... 0.30	2.7	0321-34004.1	≤ 0.20
HEP Optimo 15-6.0 G130	½"	1"	130	230	4 ... 50	... 0.46	2.7	0321-34006.1	≤ 0.23
HEP Optimo 15-7.0 G130	½"	1"	130	230	4 ... 64	... 0.60	2.7	0321-34007.1	≤ 0.23
HEP Optimo 20-4.0 G130	¾"	1¼"	130	230	4 ... 23	... 0.30	2.7	0322-34004.1	≤ 0.20
HEP Optimo 20-6.0 G130	¾"	1¼"	130	230	4 ... 50	... 0.46	2.7	0322-34006.1	≤ 0.23
HEP Optimo 20-7.0 G130	¾"	1¼"	130	230	4 ... 64	... 0.60	2.7	0322-34007.1	≤ 0.23
HEP Optimo 25-4.0 G130	1"	1½"	130	230	4 ... 23	... 0.30	2.7	0323-34004.1	≤ 0.20
HEP Optimo 25-6.0 G130	1"	1½"	130	230	4 ... 50	... 0.46	2.7	0323-34006.1	≤ 0.23
HEP Optimo 25-7.0 G130	1"	1½"	130	230	4 ... 64	... 0.60	2.7	0323-34007.1	≤ 0.23

## Constant pressure

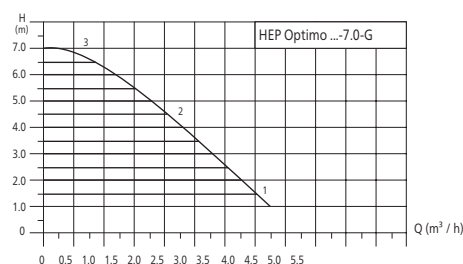
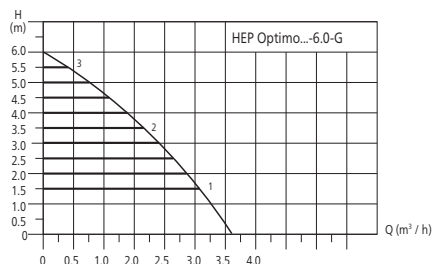
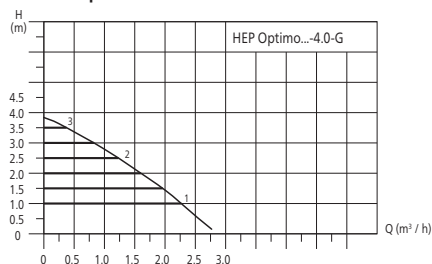

## Proportional pressure

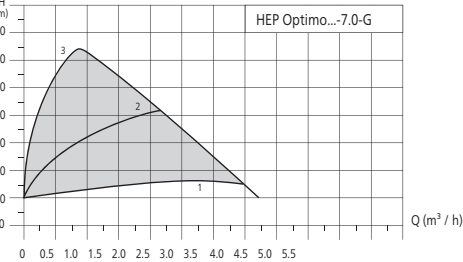
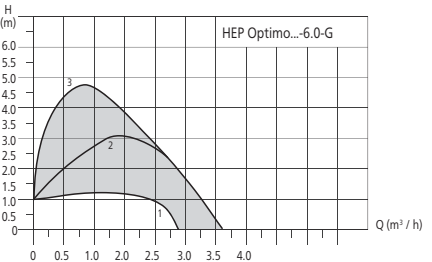
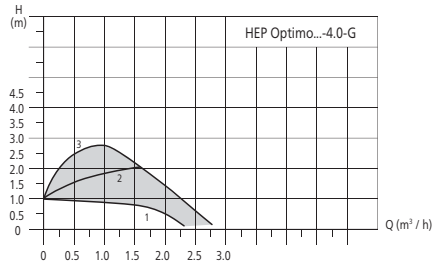

## Fixed rpm

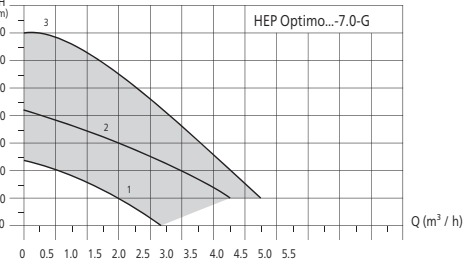
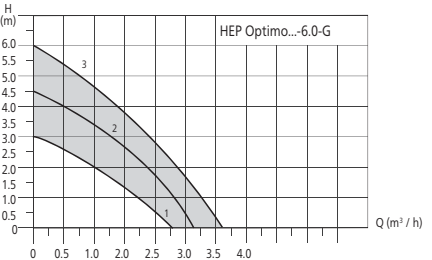
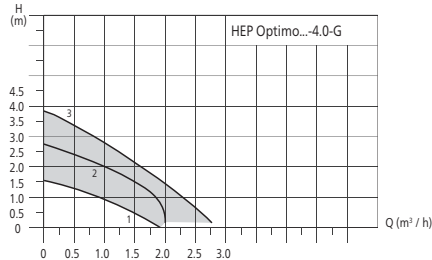

## Dimensions

Type	L1	L2	L3	L4
HEP Optimo	130/180	98	127	163

## Dimension illustration

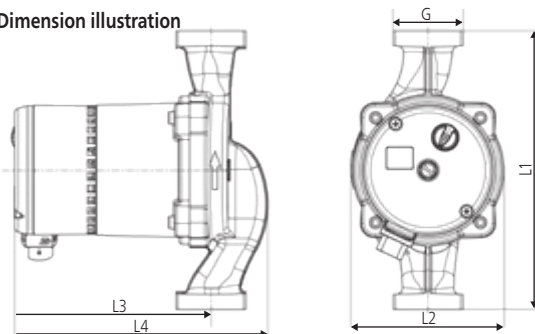

# High efficiency pumps, electronically controlled

## HEP Optimo Basic series, H1 product group



**BEST  
in class**

valid for all Halm 4 m  
High efficiency pumps



### Technical data

Rate of flow:	up to 3.2 m <sup>3</sup> /h
Pressure head:	4 m/6 m/7 m
Control range:	4-23 W/4-50 W/4 - 64 W
Media temperature:	+2 °C to +95 °C
Installation length:	130 and 180 mm
Threaded connection:	1", 1½" and 2"
Protection class:	IP 42
Insulation class:	F
Nominal pressure:	PN 10
Control:	Δpc + Δpv + fixed rpm
EEL:	≤ 0.20 HEP Optimo Basic XX-4.0 GXXX ≤ 0.23 HEP Optimo Basic XX-6.0 GXXX ≤ 0.23 HEP Optimo Basic XX-7.0 GXXX

### Product features

- manual start-up feature
- smooth running
- very low energy consumption
- integrated night economy feature
- air-vent screw
- convenient operation
- space-saving axially integrated terminal box
- automatic adjustment to pressure conditions
- cataphoretic coated pump housing
- pre-mounted cable (1 m)
- compact design

### Use

The electronically controlled HEP Optimo Basic high efficiency wet rotor circulators with permanent magnet technology are designed for use in heating systems with variable or constant rate of flow.

### Mode of operation Δp control

When thermostatic valves in systems with a long main supply heating pipe (likely for radiator systems) close, the total flow drops. This results in lower pipe resistance in this main pipe, which means the pump has to create lower head. Using proportional pressure mode PP (↖) is the best setting for such heating systems, as here the pump decreases head at lower flow.

If the main supply heating pipe has not to be taken into consideration, because it is short or has its own pump (likely for underfloor heating systems with in mixing units integrated pumps), best mode to go with is constant pressure mode CP (↔). In such heating systems, it is important always to have constant pressure for the radiators or ufh-circuits, as the pressure loss in the main pipe is not considered and all other consumers are installed in parallel, which does not influence the maximum pressure loss.

### Main areas of use

Heating, air-conditioning and industry systems as

- dual pipe system
- underfloor heating
- boiler/primary circuit
- storage charging circuit
- solar systems and heating pumps

### Materials

Component	Material	Material no.
Pump housing	Grey-cast iron	0.6020
Impeller	Polyamide (PA - GF 35)	
Shaft	Ceramic	
Bearing	Ceramic	
Bearing plate	Stainless steel	1.4301
Can	Stainless steel	1.4301

### Flow media

- heating water as per VDI 2035
- pure, thin, non-aggressive and non-explosive, mineral oil-free media without solid or long-fibre components
- media with a max. viscosity of 10 mm<sup>2</sup>/s
- operating data must be checked above 20 % glycol

### Temperature range

Ambient temperature:	0 °C to +40 °C
Temperature class:	TF 95
Media temperature:	+2 °C to +95 °C

### Ambient temperature

To avoid condensation forming in the terminal box and stator, the media temperature must always be the same or higher than the ambient temperature.

Ambient temp.	Media temp. min.	Media temp. max.
0	2	95
10	10	95
20	20	95
30	30	95
35	35	90
40	40	70

### Motor protection

External motor protection is not required.

### Integrated night economy feature

When the automatic night economy feature is activated, the circulation pump switches between normal mode and economy mode (characteristic curve MIN). The flow temperature is detected by a temperature sensor, the pump reacts accordingly. For this, it is necessary for the circulation pump to be installed in flow.

### Minimum inflow pressure

Please determine the minimum inflow pressure for corresponding temperature from the following table.

Media temperature	< 75 °C	> 90 °C
Minimum inflow pressure	0.05 bar	0.28 bar

### Sound pressure level

The sound pressure level is < 45 dB (A)

### Choice of control characteristic

You can set 3 different control modes via the potentiometer on the axial terminal box. Proportional pressure (↖), fixed speed (↗) and constant pressure (↔) can be adjusted continuously variable.







### Technical data

Type	Connection pipe	Threaded connection	Installation length (mm)	Voltage (V)	P1 (W)	In (A)	Weight (kg)	Product no.	EEL
HEP Optimo Basic 25-4.0 G180	1"	1½"	180	230	4 ... 23	... 0.30	2.7	0323-34204.2	≤ 0.20
HEP Optimo Basic 25-6.0 G180	1"	1½"	180	230	4 ... 50	... 0.46	2.7	0323-34206.2	≤ 0.23
HEP Optimo Basic 25-7.0 G180	1"	1½"	180	230	4 ... 64	... 0.60	2.7	0323-34207.2	≤ 0.23
HEP Optimo Basic 30-4.0 G180	1¼"	2"	180	230	4 ... 23	... 0.30	2.8	0324-34204.2	≤ 0.20
HEP Optimo Basic 30-6.0 G180	1¼"	2"	180	230	4 ... 50	... 0.46	2.8	0324-34206.2	≤ 0.23
HEP Optimo Basic 30-7.0 G180	1¼"	2"	180	230	4 ... 64	... 0.60	2.8	0324-34207.2	≤ 0.23
HEP Optimo Basic 15-4.0 G130	½"	1"	130	230	4 ... 23	... 0.30	2.7	0321-34004.2	≤ 0.20
HEP Optimo Basic 15-6.0 G130	½"	1"	130	230	4 ... 50	... 0.46	2.7	0321-34006.2	≤ 0.23
HEP Optimo Basic 15-7.0 G130	½"	1"	130	230	4 ... 64	... 0.60	2.7	0321-34007.2	≤ 0.23
HEP Optimo Basic 20-4.0 G130	¾"	1 ¼"	130	230	4 ... 23	... 0.30	2.7	0322-34004.2	≤ 0.20
HEP Optimo Basic 20-6.0 G130	¾"	1 ¼"	130	230	4 ... 50	... 0.46	2.7	0322-34006.2	≤ 0.23
HEP Optimo Basic 20-7.0 G130	¾"	1 ¼"	130	230	4 ... 64	... 0.60	2.7	0322-34007.2	≤ 0.23
HEP Optimo Basic 25-4.0 G130	1"	1½"	130	230	4 ... 23	... 0.30	2.7	0323-34004.2	≤ 0.20
HEP Optimo Basic 25-6.0 G130	1"	1½"	130	230	4 ... 50	... 0.46	2.7	0323-34006.2	≤ 0.23
HEP Optimo Basic 25-7.0 G130	1"	1½"	130	230	4 ... 64	... 0.60	2.7	0323-34007.2	≤ 0.23

### Constant pressure

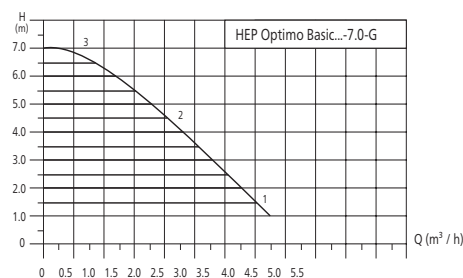
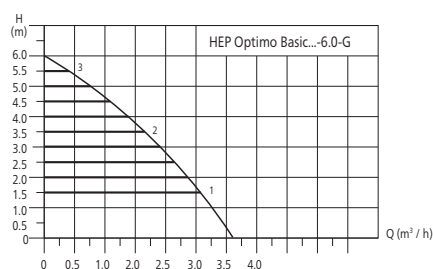
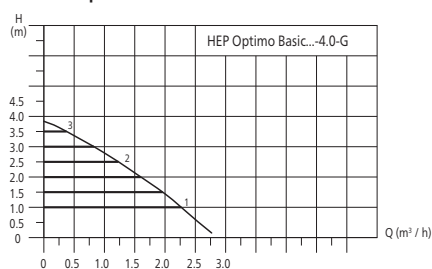

### Proportional pressure

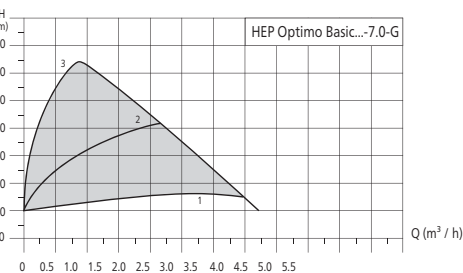
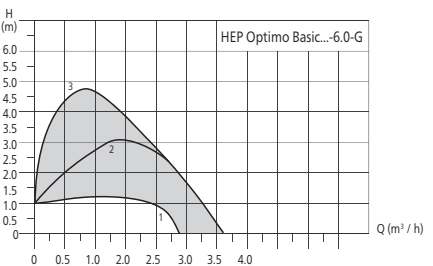
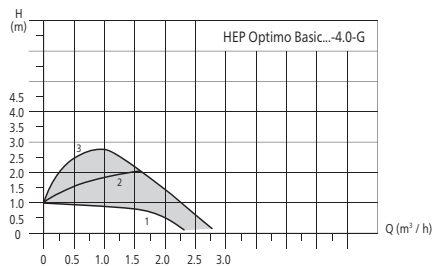

### Fixed rpm

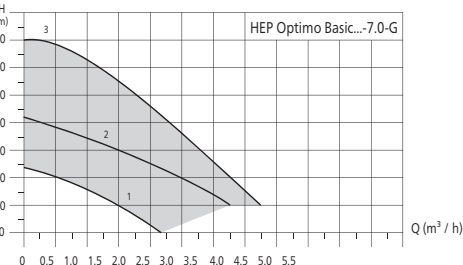
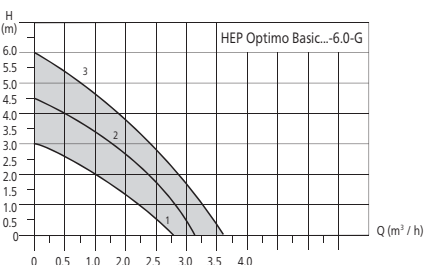
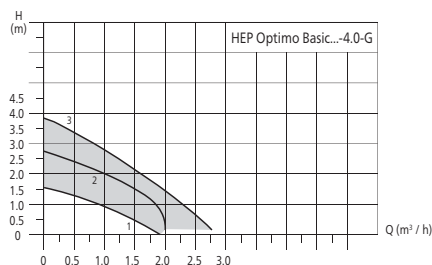

### Dimensions

Type	L1	L2	L3	L4
HEP Optimo Basic	130/180	98	127	163

### Dimension illustration

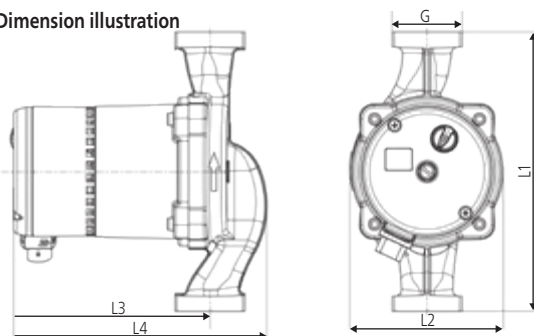

# High efficiency pumps with LCD display, electronically controlled

## HEP Optimo L series, H2 product group



Insulation shell  
included in delivery.



### Technical data

Rate of flow:	up to 10 m <sup>3</sup> /h
Pressure head:	8 m/10 m
Control range:	15-180 W/15-195 W
Media temperature:	+2 °C to +95 °C
Installation length:	180 mm (thread)/220 mm (flange)
Threaded connection:	1½" and 2" (thread)/DN 32 and DN 40 (flange)
Protection class:	IP 42
Insulation class:	F
Nominal pressure:	PN 10
EEL:	≤ 0.23 HEP Optimo L XX-8.0 G ≤ 0.23 HEP Optimo L XX-10.0 G

### Control:

Internal:	$\Delta p_c + \Delta p_v$ + fixed rpm
External:	<ul style="list-style-type: none"> <li>digital: PWM (characteristic lines for heating and solar per VDMA device paper 24224) frequency f nominal: 100-1000 Hz voltage U nominal: 5-15 V power I: 10 mA</li> <li>analogue: 0-10 V with cable break detection power I: 1 mA impedance: 10 kOhm</li> </ul>

Omnibus fault message: Selector switch, potential-free, power max. 2 A/240 VAC  
Power supply for external unit: Voltage DC 12 V, power max. 100 mA

### Product features

- LCD display
- manual start-up feature
- smooth running
- very low energy consumption
- air-vent screw
- collective fault signal
- convenient operation
- axially integrated terminal box
- automatic adjustment to pressure conditions
- cathoretic coated pump housing

### Use

The electronically controlled HEP Optimo L high efficiency wet rotor circulators with LCD display and permanent magnet technology are designed for use in heating systems with variable or constant rate of flow. The cathoretic coated pump housing is stainless.

### Main areas of use

Heating, air-conditioning and industry systems as

- dual pipe system
- single pipe system
- underfloor heating
- boiler/primary circuit
- storage charging circuit
- solar systems and heating pumps

### Controls function

You can make adjustments with the integrated control keys at the front. The LCD display shows the total electrical input power as a numeric value in [W] watts. Different icons at the top of the display show the function, setting and the modes of operation.

### Materials

Component	Material	Material No.
Pump body	Grey-cast iron	0.6020
Impeller	Polyamide (PA - GF 35)	
Shaft	Ceramic	
Bearing	Ceramic	
Bearing plate	Stainless steel	1.4301
Can	Stainless steel	1.4301

### Flow media

- heating water as per VDI 2035
- pure, thin, non-aggressive and non-explosive, mineral oil-free media without solid or long-fibre components
- media with a max. viscosity of 10 mm<sup>2</sup>/s
- operating data must be checked above 20 % glycol

### Temperature range

Ambient temperature:	0 °C to +40 °C
Temperature class:	TF 95
Media temperature:	+2 °C to +95 °C

### Ambient temperature

To avoid condensation forming in the terminal box and stator, the media temperature must always be the same or higher than the ambient temperature.

Ambient temp.	Media temp. min.	Media temp. max.
0	2	95
10	10	95
20	20	95
30	30	95
35	35	90
40	40	70

### Motor protection

External motor protection is not required.

### Minimum inflow pressure

Please determine the minimum inflow pressure for corresponding temperature from the following table.

Media temperature	< 75 °C	> 90 °C
Minimum inflow pressure	0.05 bar	0.45 bar

### Sound pressure level

The sound pressure level is < 45 dB (A)

# High efficiency pumps with LCD display, electronically controlled

HEP Optimo L series, H2 product group



## Technical data

Type	Connection pipe	Threaded connection	Flange	Installation length (mm)	Voltage (V)	P1 (W)	In (A)	Weight (kg)	Product no.	EEL
HEP Optimo L 25-8.0 G180	1"	1½"	-	180	230	15 ... 180	0.090 ... 0.90	5.96	0323-62408.1	≤ 0.23
HEP Optimo L 25-10.0 G180	1"	1½"	-	180	230	15 ... 195	0.090 ... 0.90	5.96	0323-64210.1	≤ 0.23
HEP Optimo L 30-8.0 G180	1¼"	2"	-	180	230	15 ... 180	0.090 ... 0.90	5.96	0324-62408.1	≤ 0.23
HEP Optimo L 30-10.0 G180	1¼"	2"	-	180	230	15 ... 195	0.090 ... 0.90	5.96	0324-64210.1	≤ 0.23
HEP Optimo L 32-8.0 G220	-	-	DN 32	220	230	15 ... 180	0.090 ... 0.90	6.135	0324-94208.1	≤ 0.23
HEP Optimo L 32-10.0 G220	-	-	DN 32	220	230	15 ... 195	0.090 ... 0.90	6.135	0324-94210.1	≤ 0.23
HEP Optimo L 40-8.0 G220	-	-	DN 40	220	230	15 ... 180	0.090 ... 0.90	6.135	0325-94208.1	≤ 0.23
HEP Optimo L 40-10.0 G220	-	-	DN 40	220	230	15 ... 195	0.090 ... 0.90	6.135	0325-94210.1	≤ 0.23

### Proportional pressure

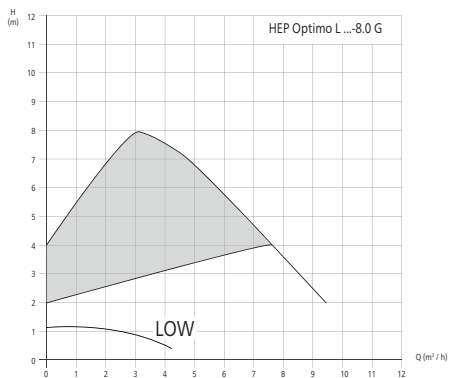

### Constant pressure

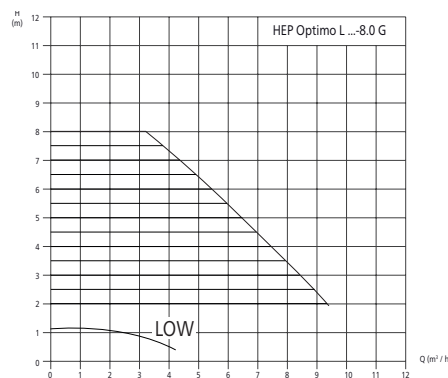

### Fixed rpm

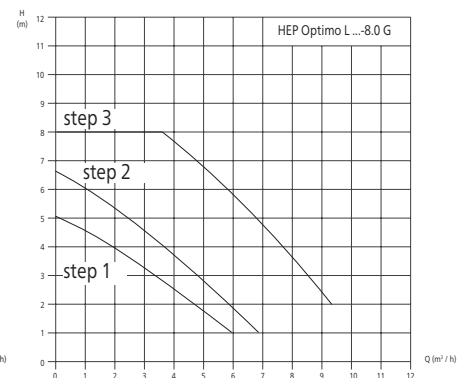

### Proportional pressure

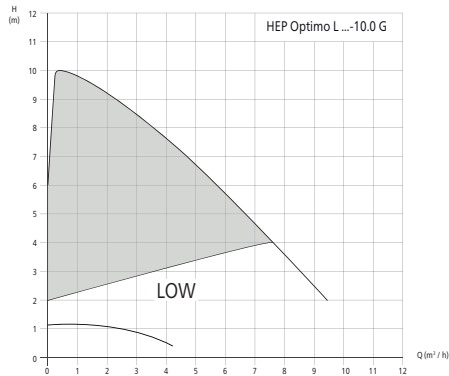

### Constant pressure

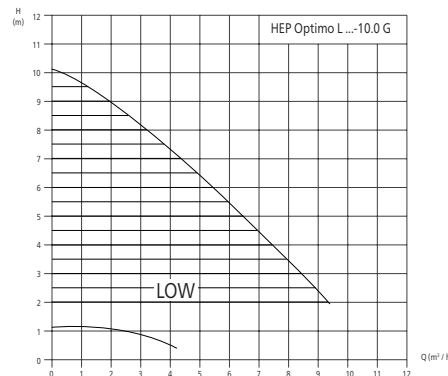

### Fixed rpm

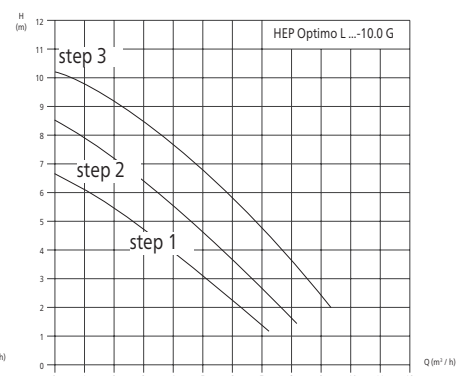

## Dimensions

Type	L1	L2	L3	L4
HEP Optimo L (thread)	180	267	178	225
HEP Optimo L (flange)	220	267	177.5	245

## Dimension illustration

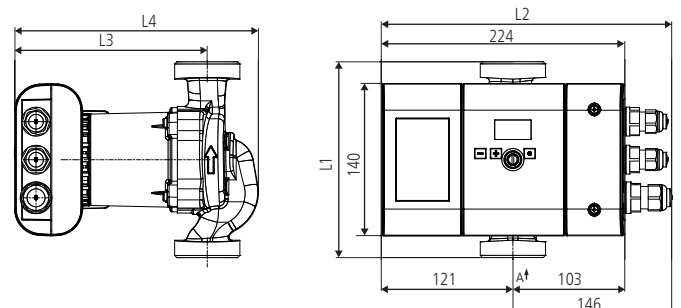

# High efficiency pumps with LED display and stainless steel housing, electronically controlled

## HEP Optimo (N) series, T1 product group



**Insulation shell**  
With installation length  
180 mm included  
in delivery.

**BEST  
in class**

valid for all Halm 4 m  
High efficiency pumps



### Technical data

Rate of flow:	up to 3.2 m <sup>3</sup> /h
Pressure head:	4 m/6 m
Control range:	4-23 W/4-50 W
Media temperature:	+2 °C to +95 °C
Installation length:	130, 150 and 180 mm
Threaded connection:	1", 1½" and 2"
Protection class:	IP 42
Insulation class:	F
Nominal pressure:	PN 10
Control:	Δpc + Δpv + fixed rpm
EEL:	≤ 0.20 HEP Optimo XX-4.0 NXXX ≤ 0.23 HEP Optimo XX-6.0 NXXX

### Product features

- manual start-up feature
- smooth running
- very low energy consumption
- integrated night economy feature
- air-vent screw
- LED display
- convenient operation
- space-saving axially integrated terminal box
- automatic adjustment to pressure conditions
- stainless steel pump housing
- pre-mounted, screwable angle entry-plug
- compact design
- optical fault indication
- optical display control mode

### Use

The electronically controlled HEP Optimo (N) high efficiency wet rotor circulators with LED display and permanent magnet technology are designed for use in heating systems as well as potable water systems with variable or constant rate of flow.

### Mode of operation Δp control

When thermostatic valves in systems with a long main supply heating pipe (likely for radiator systems) close, the total flow drops. This results in lower pipe resistance in this main pipe, which means the pump has to create lower head. Using proportional pressure mode PP (⚡) is the best setting for such heating systems, as here the pump decreases head at lower flow.

If the main supply heating pipe has not to be taken into consideration, because it is short or has its own pump (likely for underfloor heating systems with in mixing units integrated pumps or potable water systems), best mode to go with is constant pressure mode CP (⊞). In such heating systems, it is important always to have constant pressure for the radiators or ufh-circuits, as the pressure loss in the main pipe is not considered and all other consumers are installed in parallel, which does not influence the maximum pressure loss.

### Main areas of use

- potable water systems

### Materials

Component	Material	Material no.
Pump housing	Stainless steel	1.4308
Impeller	Polyamide (PA - GF 35)	
Shaft	Ceramic	
Bearing	Ceramic	
Bearing plate	Stainless steel	1.4301
Can	Stainless steel	1.4301

### Flow media

- potable water and heated potable water to a temperature of 65 °C and a degree of hardness of 14 °dH (temporary hardness)
- heating water as per VDI 2035
- pure, thin, non-aggressive and non-explosive, mineral oil-free media without solid or long-fibre components
- media with a max. viscosity of 10 mm<sup>2</sup>/s
- operating data must be checked above 20 % glycol

### Temperature range

Ambient temperature:	0 °C to +40 °C
Temperature class:	TF 95
Media temperature:	+2 °C to +95 °C

### Ambient temperature

To avoid condensation forming in the terminal box and stator, the media temperature must always be the same or higher than the ambient temperature.

Ambient temp.	Media temp. min.	Media temp. max.
0	2	95
10	10	95
20	20	95
30	30	95
35	35	90
40	40	70

### Motor protection

External motor protection is not required.

### Integrated night economy feature

When the automatic night economy feature is activated, the circulation pump switches between normal mode and economy mode (characteristic curve MIN). The flow temperature is detected by a temperature sensor, the pump reacts accordingly. For this, it is necessary for the circulation pump to be installed in flow.

### Minimum inflow pressure

Please determine the minimum inflow pressure for corresponding temperature from the following table.

Media temperature	< 75 °C	> 90 °C
Minimum inflow pressure	0.05 bar	0.28 bar

### Sound pressure level

The sound pressure level is < 45 dB (A)

### Choice of control characteristic

You can set 3 different control modes via the potentiometer on the axial terminal box. Proportional pressure (⚡), fixed speed (⚡) and constant pressure (⊞) can be adjusted continuously variable. The display indicates power consumption in [W] watts. Once the potentiometer is turned, the display first indicates mode of operation (PP, SC, CP), then value of set head in [m] meters. At the factory setting the potentiometer is in mode PP.



# High efficiency pumps with LED display and stainless steel housing, electronically controlled

HEP Optimo (N) series, T1 product group



## Technical data

Type	Connection pipe	Threaded connection	Installation length (mm)	Voltage (V)	P1 (W)	In (A)	Weight (kg)	Product no.	EEl
HEP Optimo 25-4.0 N180	1"	1½"	180	230	4 ... 23	... 0.30	2.7	0353-34204.1	≤ 0.20
HEP Optimo 25-6.0 N180	1"	1½"	180	230	4 ... 50	... 0.46	2.7	0353-34206.1	≤ 0.23
HEP Optimo 15-4.0 N130	½"	1"	130	230	4 ... 23	... 0.30	2.7	0351-34004.1	≤ 0.20
HEP Optimo 15-6.0 N130	½"	1"	130	230	4 ... 50	... 0.46	2.7	0351-34006.1	≤ 0.23
HEP Optimo 20-4.0 N150	¾"	1¼"	150	230	4 ... 23	... 0.30	2.7	0352-34104.1	≤ 0.20
HEP Optimo 20-6.0 N150	¾"	1¼"	150	230	4 ... 50	... 0.46	2.7	0352-34106.1	≤ 0.23
HEP Optimo 25-4.0 N130	1"	1½"	130	230	4 ... 23	... 0.30	2.7	0353-34004.1	≤ 0.20
HEP Optimo 25-6.0 N130	1"	1½"	130	230	4 ... 50	... 0.46	2.7	0353-34006.1	≤ 0.23

## Constant pressure

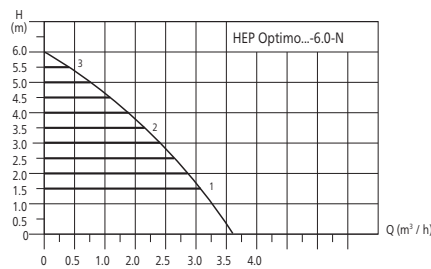
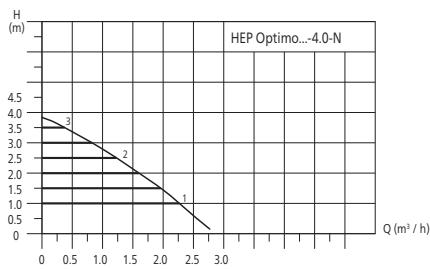

## Proportional pressure

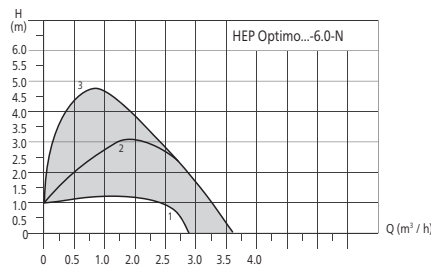
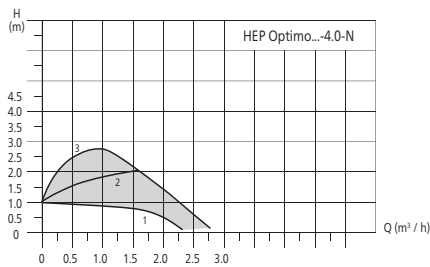

## Fixed rpm

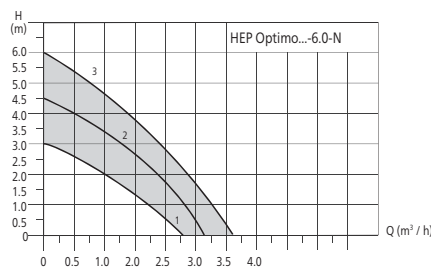
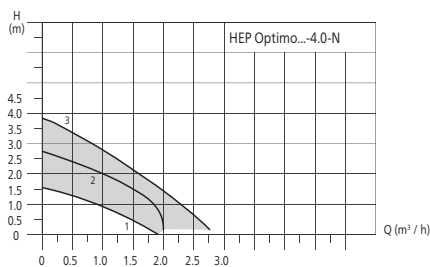

## Dimensions

Type	L1	L2	L3	L4
HEP Optimo (N)	130/150/180	98	127	163

## Dimension illustration

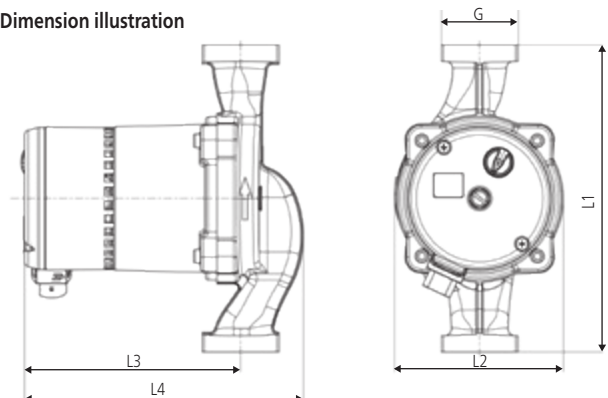



# High efficiency pumps with stainless steel housing, electronically controlled

## HEP Optimo Basic (N) series, T1 product group



**BEST  
in class**

valid for all Halm 4 m  
High efficiency pumps



### Technical data

Rate of flow:	up to 3.2 m <sup>3</sup> /h
Pressure head:	4 m/6 m
Control range:	4-23 W/4-50 W
Media temperature:	+2 °C to +95 °C
Installation length:	130, 150 and 180 mm
Threaded connection:	1", 1½" and 2"
Protection class:	IP 42
Insulation class:	F
Nominal pressure:	PN 10
Control:	Δpc + Δpv + fixed rpm
EEL:	≤ 0.20 HEP Optimo Basic XX-4.0 NXXX ≤ 0.23 HEP Optimo Basic XX-6.0 NXXX

### Product features

- manual start-up feature
- smooth running
- very low energy consumption
- integrated night economy feature
- air-vent screw
- convenient operation
- space-saving axially integrated terminal box
- automatic adjustment to pressure conditions
- stainless steel pump housing
- pre-mounted cable (1 m)
- compact design

### Use

The electronically controlled HEP Optimo Basic (N) high efficiency wet rotor circulators with permanent magnet technology are designed for use in heating systems as well as potable water systems with variable or constant rate of flow.

### Mode of operation Δp control

When thermostatic valves in systems with a long main supply heating pipe (likely for radiator systems) close, the total flow drops. This results in lower pipe resistance in this main pipe, which means the pump has to create lower head. Using proportional pressure mode PP (⚡) is the best setting for such heating systems, as here the pump decreases head at lower flow.

If the main supply heating pipe has not to be taken into consideration, because it is short or has its own pump (likely for underfloor heating systems with in mixing units integrated pumps or potable water systems), best mode to go with is constant pressure mode CP (⊞). In such heating systems, it is important always to have constant pressure for the radiators or ufh-circuits, as the pressure loss in the main pipe is not considered and all other consumers are installed in parallel, which does not influence the maximum pressure loss.

### Main areas of use

- potable water systems

### Materials

Component	Material	Material no.
Pump housing	Stainless steel	1.4308
Impeller	Polyamide (PA - GF 35)	
Shaft	Ceramic	
Bearing	Ceramic	
Bearing plate	Stainless steel	1.4301
Can	Stainless steel	1.4301

### Flow media

- potable water and heated potable water to a temperature of 65 °C and a degree of hardness of 14 °dH (temporary hardness)
- heating water as per VDI 2035
- pure, thin, non-aggressive and non-explosive, mineral oil-free media without solid or long-fibre components
- media with a max. viscosity of 10 mm<sup>2</sup>/s
- operating data must be checked above 20 % glycol

### Temperature range

Ambient temperature:	0 °C to +40 °C
Temperature class:	TF 95
Media temperature:	+2 °C to +95 °C

### Ambient temperature

To avoid condensation forming in the terminal box and stator, the media temperature must always be the same or higher than the ambient temperature.

Ambient temp.	Media temp. min.	Media temp. max.
0	2	95
10	10	95
20	20	95
30	30	95
35	35	90
40	40	70

### Motor protection

External motor protection is not required.

### Integrated night economy feature

When the automatic night economy feature is activated, the circulation pump switches between normal mode and economy mode (characteristic curve MIN). The flow temperature is detected by a temperature sensor, the pump reacts accordingly. For this, it is necessary for the circulation pump to be installed in flow.

### Minimum inflow pressure

Please determine the minimum inflow pressure for corresponding temperature from the following table.

Media temperature	< 75 °C	> 90 °C
Minimum inflow pressure	0.05 bar	0.28 bar

### Sound pressure level

The sound pressure level is < 45 dB (A)

### Choice of control characteristic

You can set 3 different control modes via the potentiometer on the axial terminal box. Proportional pressure (⚡), fixed speed (⚡) and constant pressure (⊞) can be adjusted continuously variable.

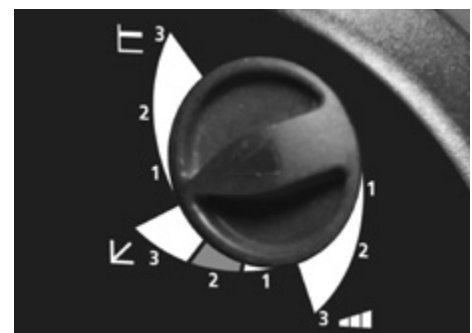

# High efficiency pumps with stainless steel housing, electronically controlled

HEP Optimo Basic (N) series, T1 product group



## Technical data

Type	Connection pipe	Threaded connection	Installation length (mm)	Voltage (V)	P1 (W)	In (A)	Weight (kg)	Product no.	EEl
HEP Optimo Basic 25-4.0 N180	1"	1½"	180	230	4 ... 23	... 0.30	2.7	0353-34204.2	≤ 0.20
HEP Optimo Basic 25-6.0 N180	1"	1½"	180	230	4 ... 50	... 0.46	2.7	0353-34206.2	≤ 0.23
HEP Optimo Basic 15-4.0 N130	½"	1"	130	230	4 ... 23	... 0.30	2.7	0351-34004.2	≤ 0.20
HEP Optimo Basic 15-6.0 N130	½"	1"	130	230	4 ... 50	... 0.46	2.7	0351-34006.2	≤ 0.23
HEP Optimo Basic 20-4.0 N150	¾"	1 ¼"	150	230	4 ... 23	... 0.30	2.7	0352-34104.2	≤ 0.20
HEP Optimo Basic 20-6.0 N150	¾"	1 ¼"	150	230	4 ... 50	... 0.46	2.7	0352-34106.2	≤ 0.23
HEP Optimo Basic 25-4.0 N130	1"	1½"	130	230	4 ... 23	... 0.30	2.7	0353-34004.2	≤ 0.20
HEP Optimo Basic 25-6.0 N130	1"	1½"	130	230	4 ... 50	... 0.46	2.7	0353-34006.2	≤ 0.23

## Constant pressure

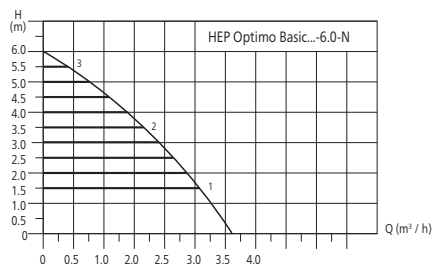
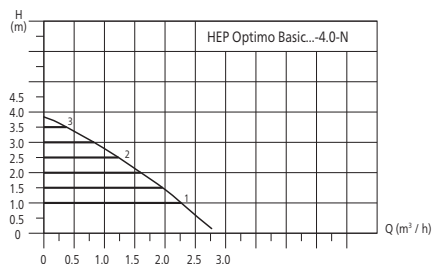

## Proportional pressure

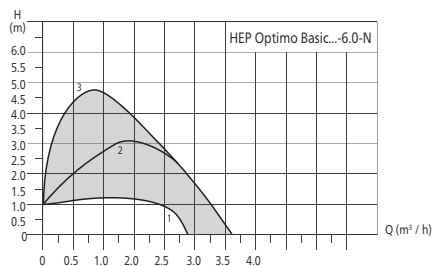
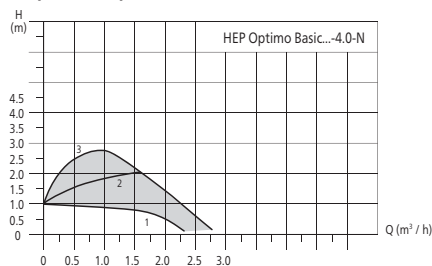

## Fixed rpm

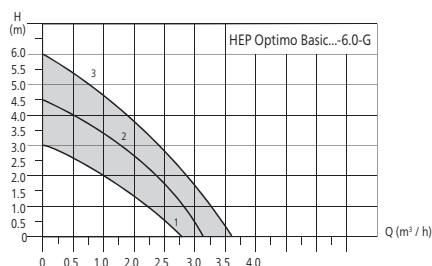
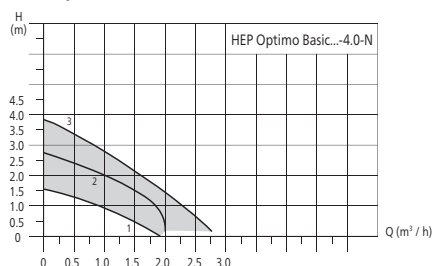

## Dimensions

Type	L1	L2	L3	L4
HEP Optimo Basic (N)	130/180	98	127	163

## Dimension illustration

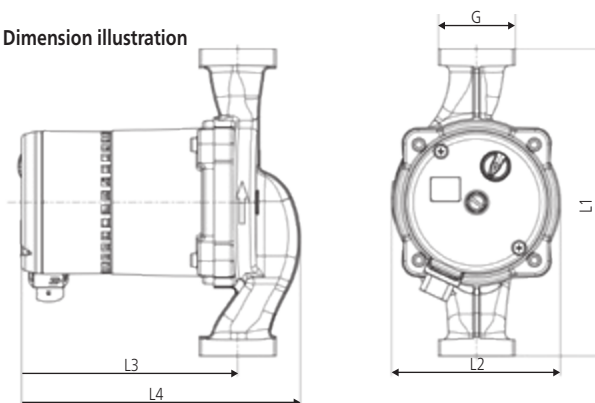

# Standard circulation pumps for potable water with stainless steel housing

## BUPA (N) series, T3 product group



### Technical data

Rate of flow:	up to 4.0 m <sup>3</sup> /h
Pressure head:	up to 6 m
Media temperature:	+2 °C to +110 °C
Installation length:	130, 150 and 180 mm
Threaded connection:	1", 1¼" and 1½"
Protection class:	IP 44
Insulation class:	H
Nominal pressure:	PN 10
Control:	3-step switch with manual speed selection

### Product features

- manual start-up feature
- space-saving axially integrated terminal box

### Use

The BUPA (N) series circulation pumps are wet rotor circulators designed for use in potable water systems with constant or weakly variable flow rates. They feature a corrosion-resistant pump housing in stainless steel and are thus suitable for use in potable water circulation systems.

### Materials

Component	Material	Material no.
Pump housing	Stainless steel	1.4308
Impeller	PSU - GF 20	
Shaft	Ceramic	
Bearing	Ceramic	
Bearing plate	Stainless steel	1.4301
Can	Stainless steel	1.4301

### Temperature range

Ambient temperature:	0 °C to +40 °C
Temperature class:	TF 110
Media temperature:	+2 °C to +110 °C

### Ambient temperature

To avoid condensation forming in the terminal box and stator, the media temperature must always be the same or higher than the ambient temperature.

Ambient temp.	Media temp. min.	Media temp. max.
0	2	110
10	10	110
20	20	110
30	30	110
35	35	110
40	40	110

### Motor protection

External motor protection is not required.

### Speed switching

The respective speed is set via a rotary switch integrated in the axial terminal box.

### Minimum inflow pressure

Please determine the minimum inflow pressure for corresponding temperature from the following table.

Media temperature	< 85 °C	90 °C	110 °C
Minimum inflow pressure	0.05 bar	0.3 bar	1.10 bar

### Sound pressure level

The sound pressure level is < 45 dB (A)

### Flow media

- potable water and heated potable water to a temperature of 65 °C and a degree of hardness of 14 °dH (temporary hardness)
- heating water as per VDI 2035
- pure, thin, non-aggressive and non-explosive, mineral oil-free media without solid or long-fibre components
- media with a max. viscosity of 10 mm<sup>2</sup>/s

# Standard circulation pumps for potable water with stainless steel housing

BUPA (N) series, T3 product group



## Technical data

Type	Connection pipe	Threaded connection	Installation length (mm)	Voltage (V)	P1 (W)	In (A)	Weight (kg)	Product no.
BUPA 25-2.5 N180	1"	1½"	180	230	27 ... 35	0.17 ... 0.30	2.8	0353-30203
BUPA 25-4.0 N180	1"	1½"	180	230	33 ... 44	0.19 ... 0.33	2.8	0353-30204
BUPA 25-6.0 N180	1"	1½"	180	230	43 ... 80	0.27 ... 0.44	2.8	0353-30206
BUPA 15-2.5 N130	½"	1"	130	230	27 ... 35	0.17 ... 0.30	2.7	0351-30003
BUPA 15-4.0 N130	½"	1"	130	230	33 ... 44	0.19 ... 0.33	2.7	0351-30004
BUPA 15-6.0 N130	½"	1"	130	230	43 ... 80	0.27 ... 0.44	2.7	0351-30006
BUPA 20-2.5 N150	¾"	1¼"	150	230	27 ... 35	0.17 ... 0.30	2.7	0352-30103
BUPA 20-4.0 N150	¾"	1¼"	150	230	33 ... 44	0.19 ... 0.33	2.7	0352-30104
BUPA 20-6.0 N150	¾"	1¼"	150	230	43 ... 80	0.27 ... 0.44	2.7	0352-30106
BUPA 25-2.5 N130	1"	1½"	130	230	27 ... 35	0.17 ... 0.30	2.7	0353-30003
BUPA 25-4.0 N130	1"	1½"	130	230	33 ... 44	0.19 ... 0.33	2.7	0353-30004
BUPA 25-6.0 N130	1"	1½"	130	230	43 ... 80	0.27 ... 0.44	2.7	0353-30006

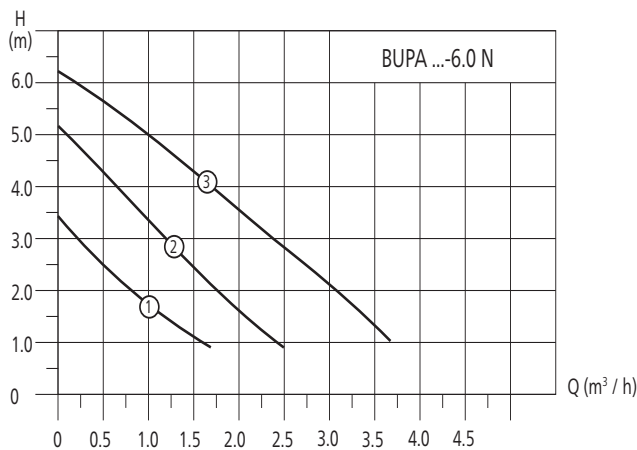
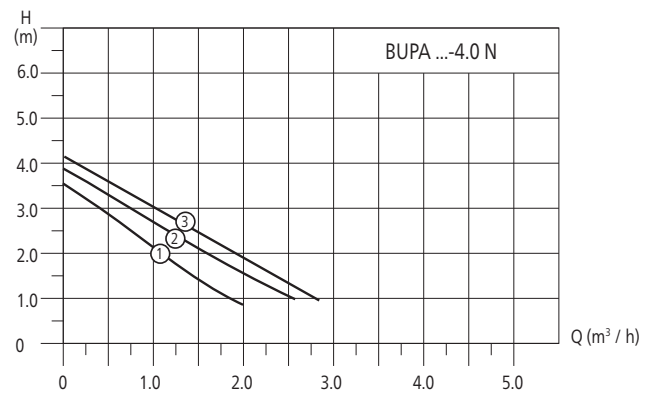
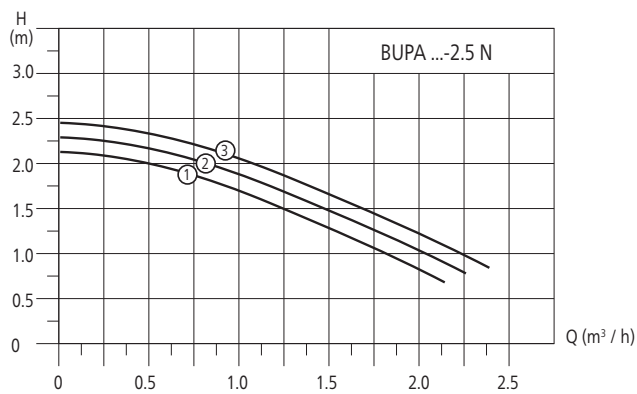

## Dimensions

Type	L1	L2	L3	L4
BUPA (N)	130/150/180	98	108	145

## Dimension illustration

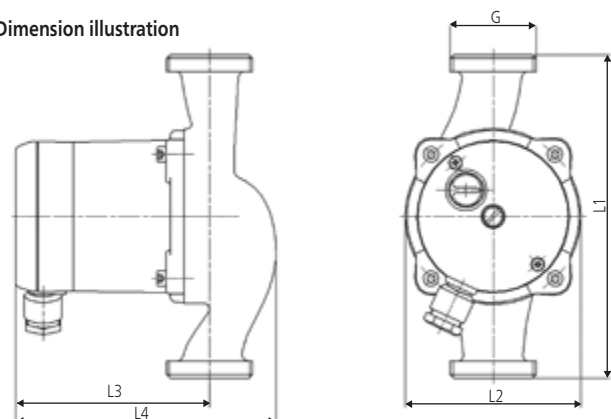

# Circulation pumps for potable water with stainless steel housing, pressure head 7-12 m

## BGPA (N) series, T3 product group



### Technical data

Rate of flow:	up to 12.0 m <sup>3</sup> /h
Pressure head:	up to 12 m
Media temperature:	+2 °C to +110 °C
Installation length:	180 mm
Threaded connection:	1¼" and 1½"
Protection class:	IP 44
Insulation class:	H
Nominal pressure:	PN 10
Control:	3-step switch with manual speed selection

### Product features

- manual start-up feature
- space-saving axially integrated terminal box
- pump housing in stainless steel

### Use

The BGPA (N) series circulation pumps are wet rotor circulators designed for use in potable water systems with a flow rate of > 5 m<sup>3</sup>/h. They feature a corrosion-resistant housing in stainless steel and are thus designed for use in potable water circulation systems.

### Materials

Component	Material	Material no.
Pump housing	Stainless steel	1.4308
Impeller	Polypropylene (PP - GF 30)	
Shaft	Ceramic	
Bearing	Ceramic	
Bearing plate	Brass	2.0401
Can	Stainless steel	1.4301

### Temperature range

Ambient temperature:	0 °C to +40 °C
Temperature class:	TF 110
Media temperature:	+2 °C to +110 °C

### Ambient temperature

To avoid the build-up of condensation, the ambient temperature must always be lower than the media temperature.

Ambient temp.	Media temp. min.	Media temp. max.
0	2	110
10	10	110
20	20	110
30	30	110
35	35	110
40	40	110

### Motor protection

External motor protection is not required.

### Speed switching

The respective speed is set via a rotary switch integrated in the axial terminal box.

### Minimum inflow pressure

Please determine the minimum inflow pressure for corresponding temperature from the following table.

Media temperature	< 85 °C	90 °C	110 °C
Minimum inflow pressure	0.05 bar	0.3 bar	1.10 bar

### Sound pressure level

The sound pressure level is < 45 dB (A)

### Flow media

- potable water and heated potable water to a temperature of 65 °C and a degree of hardness of 14 °dH (temporary hardness)
- heating water as per VDI 2035
- pure, thin, non-aggressive and non-explosive, mineral oil-free media without solid or long-fibre components
- media with a max. viscosity of 10 mm<sup>2</sup>/s



# Circulation pumps for potable water with stainless steel housing, pressure head 7-12 m

BGPA (N) series, T3 product group



## Technical data

Type	Connection pipe	Threaded connection	Installation length (mm)	Voltage (V)	P1 (W)	In (A)	Weight (kg)	Product no.
BGPA 20-7.0 N180	¾"	1¼"	180	230	220 ... 260	1.03 ... 1.13	6.5	0352-40207
BGPA 20-8.0 N180	¾"	1¼"	180	230	260 ... 286	1.23 ... 1.25	6.5	0352-40208
BGPA 20-10.0 N180	¾"	1¼"	180	230	283 ... 357	1.35 ... 1.56	6.5	0352-40210
BGPA 20-12.0 N180	¾"	1¼"	180	230	285 ... 400	1.36 ... 1.73	6.5	0352-40212
BGPA 25-7.0 N180	1"	1½"	180	230	220 ... 260	1.03 ... 1.13	6.5	0353-40207
BGPA 25-8.0 N180	1"	1½"	180	230	260 ... 286	1.23 ... 1.25	6.5	0353-40208
BGPA 25-10.0 N180	1"	1½"	180	230	283 ... 357	1.35 ... 1.56	6.5	0353-40210
BGPA 25-12.0 N180	1"	1½"	180	230	285 ... 400	1.36 ... 1.73	6.5	0353-40212

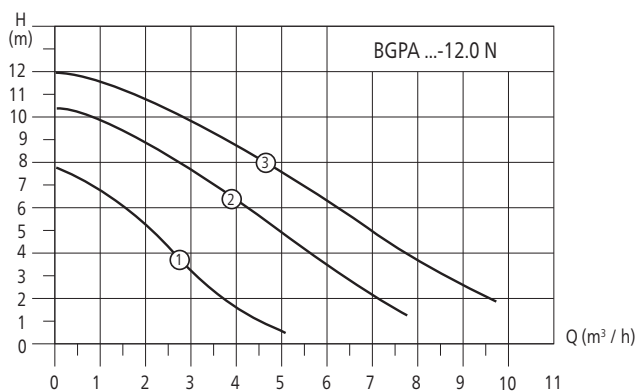
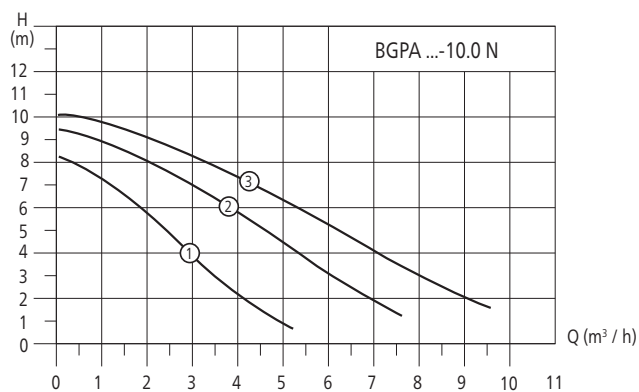
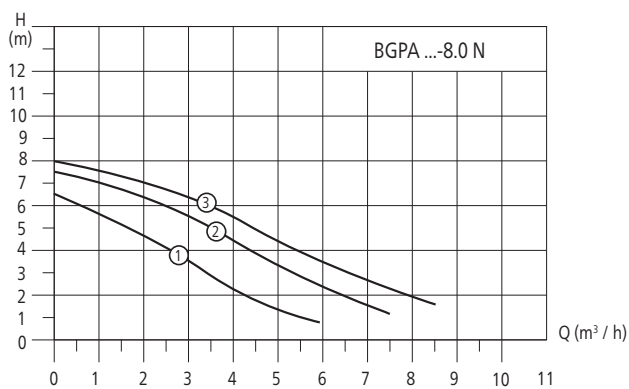
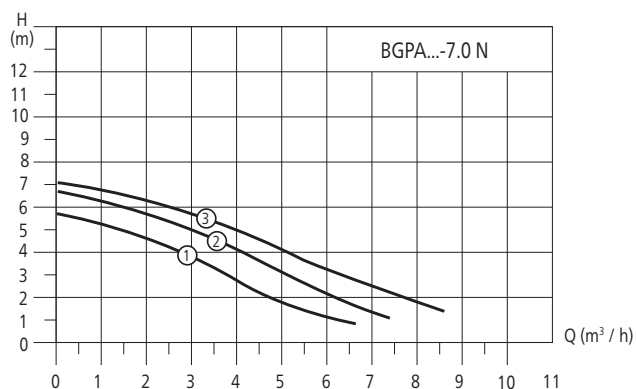

## Dimensions

Type	L1	L2	L3	L4
BGPA (N)	180	135.5	166	206

## Dimension illustration

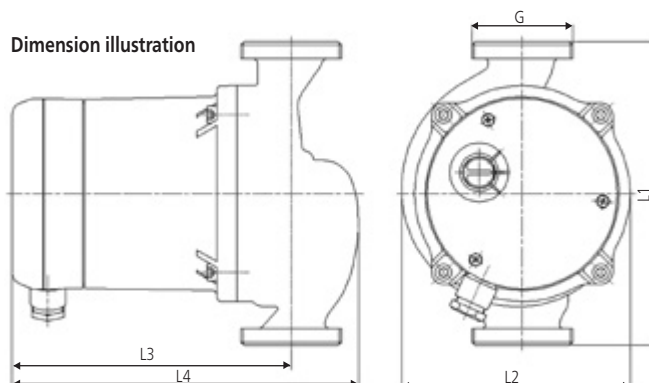

# High efficiency pumps with LED display, electronically controlled

## HEP Optimo Solar series, S1 product group



**Insulation shell**  
With installation length  
180 mm included  
in delivery.

**BEST  
in class**  
valid for all Halm 4 m  
High efficiency pumps



### Technical data

Rate of flow:	up to 3.2 m <sup>3</sup> /h
Pressure head:	4 m/6 m
Control range:	4-23 W/4-50 W
Media temperature:	+2 °C to +110 °C
Installation length:	130 and 180 mm
Threaded connection:	1, 1½" and 2"
Protection class:	IP 42
Insulation class:	F
Nominal pressure:	PN 10
Control:	Δpc + Δpv + fixed rpm
EEL:	≤ 0.20 HEP Optimo Solar XX-4.0 GXXX ≤ 0.23 HEP Optimo Solar XX-6.0 GXXX

### Product features

- manual start-up feature
- smooth running
- very low energy consumption
- integrated night economy feature
- air-vent screw
- LED display
- convenient operation
- space-saving axially integrated terminal box
- automatic adjustment to pressure conditions
- cataphoretic coated pump housing
- pre-mounted, screwable angle entry-plug
- compact design

### Use

The electronically controlled HEP Optimo Solar high efficiency wet rotor circulators with LED display and permanent magnet technology are designed for use in solar systems with variable or constant rate of flow. The cataphoretic coated pump housing is stainless.

### Mode of operation Δp control

When thermostatic valves in systems with a long main supply heating pipe (likely for radiator systems) close, the total flow drops. This results in lower pipe resistance in this main pipe, which means the pump has to create lower head. Using proportional pressure mode PP (⚡) is the best setting for such heating systems, as here the pump decreases head at lower flow.

If the main supply heating pipe has not to be taken into consideration, because it is short or has its own pump (likely for underfloor heating systems with in mixing units integrated pumps or solar systems), best mode to go with is constant pressure mode CP (⊞). In such heating systems, it is important always to have constant pressure for the radiators or ufh-circuits, as the pressure loss in the main pipe is not considered and all other consumers are installed in parallel, which does not influence the maximum pressure loss.

### Main areas of use

- solar systems

### Materials

Component	Material	Material no.
Pump housing	Grey-cast iron	0.6020
Impeller	Polyamide (PA - GF 35)	
Shaft	Ceramic	
Bearing	Ceramic	
Bearing plate	Stainless steel	1.4301
Can	Stainless steel	1.4301

### Flow media

- heating water as per VDI 2035
- pure, thin, non-aggressive and non-explosive, mineral oil-free media without solid or long-fibre components
- media with a max. viscosity of 10 mm<sup>2</sup>/s
- operating data must be checked above 20 % glycol

### Temperature range

Ambient temperature:	0 °C to +40 °C
Temperature class:	TF 110
Media temperature:	+2 °C to +110 °C

### Ambient temperature

To avoid condensation forming in the terminal box and stator, the media temperature must always be the same or higher than the ambient temperature.

Ambient temp.	Media temp. min.	Media temp. max.
0	2	110
10	10	110
20	20	110
30	30	95
35	35	90
40	40	70

### Motor protection

External motor protection is not required.

### Integrated night economy feature

When the automatic night economy feature is activated, the circulation pump switches between normal mode and economy mode (characteristic curve MIN). The flow temperature is detected by a temperature sensor, the pump reacts accordingly. For this, it is necessary for the circulation pump to be installed in flow.

### Minimum inflow pressure

Please determine the minimum inflow pressure for corresponding temperature from the following table.

Media temperature	< 75 °C	> 90 °C
Minimum inflow pressure	0.05 bar	0.28 bar

### Sound pressure level

The sound pressure level is < 45 dB (A)

### Choice of control characteristic

You can set 3 different control modes via the potentiometer on the axial terminal box. Proportional pressure (⚡), fixed speed (⚡) and constant pressure (⊞) can be adjusted continuously variable. The display indicates power consumption in [W] watts. Once the potentiometer is turned, the display first indicates mode of operation (PP, SC, CP), then value of set head in [m] meters. At the factory setting the potentiometer is in mode PP.



# High efficiency pumps with LED display, electronically controlled

HEP Optimo Solar series, S1 product group



## Technical data

Type	Connection pipe	Threaded connection	Installation length (mm)	Voltage (V)	P1 (W)	In (A)	Weight (kg)	Product no.	EEL
HEP Optimo Solar 25-4.0 G180	1"	1½"	180	230	4 ... 23	... 0.30	2.7	0313-34204.1	≤ 0.20
HEP Optimo Solar 25-6.0 G180	1"	1½"	180	230	4 ... 50	... 0.46	2.7	0313-34206.1	≤ 0.23
HEP Optimo Solar 30-4.0 G180	1¼"	2"	180	230	4 ... 23	... 0.30	2.8	0314-34204.1	≤ 0.20
HEP Optimo Solar 30-6.0 G180	1¼"	2"	180	230	4 ... 50	... 0.46	2.8	0314-34206.1	≤ 0.23
HEP Optimo Solar 15-4.0 G130	½"	1"	130	230	4 ... 23	... 0.30	2.7	0311-34004.1	≤ 0.20
HEP Optimo Solar 15-6.0 G130	½"	1"	130	230	4 ... 50	... 0.46	2.7	0311-34006.1	≤ 0.23
HEP Optimo Solar 20-4.0 G130	¾"	1¼"	130	230	4 ... 23	... 0.30	2.7	0312-34004.1	≤ 0.20
HEP Optimo Solar 20-6.0 G130	¾"	1¼"	130	230	4 ... 50	... 0.46	2.7	0312-34006.1	≤ 0.23
HEP Optimo Solar 25-4.0 G130	1"	1½"	130	230	4 ... 23	... 0.30	2.7	0313-34004.1	≤ 0.20
HEP Optimo Solar 25-6.0 G130	1"	1½"	130	230	4 ... 50	... 0.46	2.7	0313-34006.1	≤ 0.23

## Constant pressure

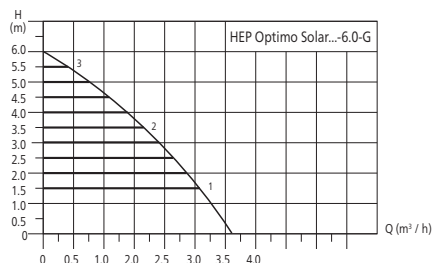
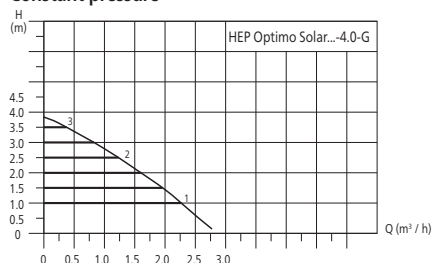

## Proportional pressure

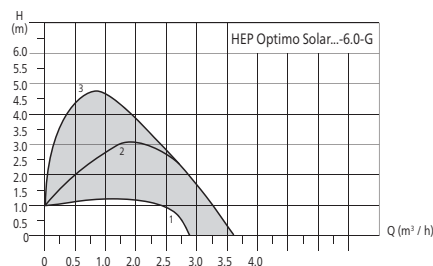
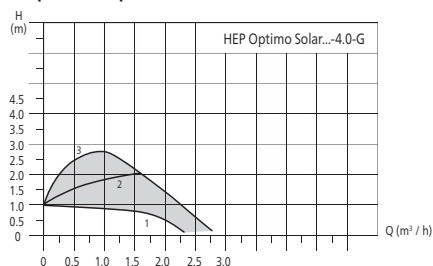

## Fixed rpm

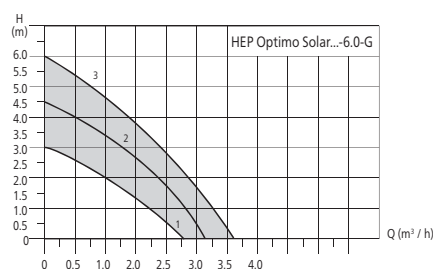
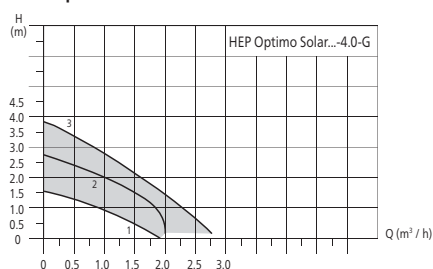

## Dimensions

Type	L1	L2	L3	L4
HEP Optimo Solar	130/180	98	127	163

## Dimension illustration

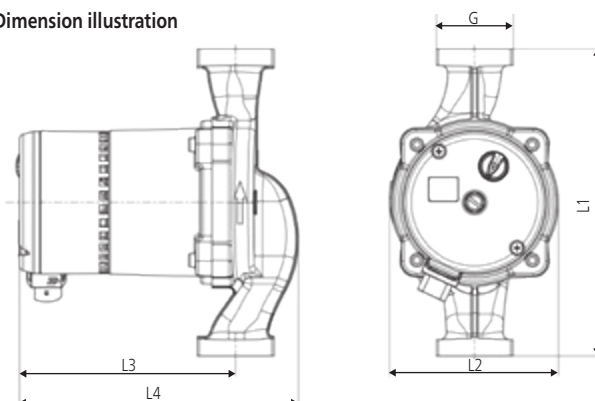

# High efficiency pumps with LCD display, electronically controlled

HEP Optimo L Solar series, S2 product group



## Technical data

Rate of flow: up to 10 m<sup>3</sup>/h  
 Pressure head: 8 m/10 m  
 Control range: 15-180 W/15-195 W  
 Media temperature: +2 °C to +110 °C  
 Installation length: 180 mm (thread)/220 mm (flange)  
 Threaded connection: 1½" and 2" (thread)/DN 32 and DN 40 (flange)  
 Protection class: IP 42  
 Insulation class: F  
 Nominal pressure: PN 10  
 EEI: ≤ 0.23 HEP Optimo L XX-8.0 G  
 ≤ 0.23 HEP Optimo L XX-10.0 G

## Control:

Internal: Δpc + Δpv + fixed rpm  
 External:
 

- digital: PWM (characteristic lines for heating and solar per VDMA device paper 24224)  
 frequency f nominal: 100-1000 Hz  
 voltage U nominal: 5-15 V  
 power I: 10 mA
- analogue: 0-10 V with cable break detection  
 power I: 1 mA  
 impedance: 10 kOhm

Omnibus fault message: Selector switch, potential-free, power max. 2 A/240 VAC  
 Power supply for external unit: Voltage DC 12 V, power max. 100 mA

## Product features

- LCD display
- manual start-up feature
- smooth running
- very low energy consumption
- air-vent screw
- collective fault signal
- convenient operation
- axially integrated terminal box
- automatic adjustment to pressure conditions
- cataphoretic coated pump housing

## Use

The electronically controlled HEP Optimo L Solar high efficiency wet rotor circulators with LCD display and permanent magnet technology are designed for use in heating systems with variable or constant rate of flow. The cataphoretic coated pump housing is stainless.

## Main areas of use

- solar systems

## Controls Function

You can make adjustments with the integrated control keys at the front. The LCD display shows the total electrical input power as a numeric value in [W] watts. Different icons at the top of the display show the function, setting and the modes of operation.

## Materials

Component	Material	Material No.
Pump body	Grey-cast iron	0.6020
Impeller	Polyamide (PA - GF 35)	
Shaft	Ceramic	
Bearing	Ceramic	
Bearing plate	Stainless steel	1.4301
Can	Stainless steel	1.4301

## Flow media

- heating water as per VDI 2035
- pure, thin, non-aggressive and non-explosive, mineral oil-free media without solid or long-fibre components
- media with a max. viscosity of 10 mm<sup>2</sup>/s
- operating data must be checked above 20 % glycol

## Temperature range

Ambient temperature: 0 °C to +40 °C  
 Temperature class: TF 110  
 Media temperature: +2 °C to +110 °C

## Ambient temperature

To avoid condensation forming in the terminal box and stator, the media temperature must always be the same or higher than the ambient temperature.

Ambient temp.	Media temp. min.	Media temp. max.
0	2	110
10	10	110
20	20	110
30	30	95
35	35	90
40	40	70

## Motor protection

External motor protection is not required.

## Minimum inflow pressure

Please determine the minimum inflow pressure for corresponding temperature from the following table.

Media temperature	< 75 °C	> 90 °C
Minimum inflow pressure	0.05 bar	0.45 bar

## Sound pressure level

The sound pressure level is < 45 dB (A)

# High efficiency pumps with LCD display, electronically controlled

HEP Optimo L series, S2 product group



## Technical data

Type	Connection pipe	Threaded connection	Flange	Installation length (mm)	Voltage (V)	P1 (W)	In (A)	Weight (kg)	Product no.	EEl
HEP Optimo L Solar 25-8.0 G180	1"	1½"	-	180	230	15 ... 180	0.090 ... 0.90	5.96	0313-62408.1	≤ 0.23
HEP Optimo L Solar 25-10.0 G180	1"	1½"	-	180	230	15 ... 195	0.090 ... 0.90	5.0	0313-64210.1	≤ 0.23
HEP Optimo L Solar 30-8.0 G180	1¼"	2"	-	180	230	15 ... 180	0.090 ... 0.90	5.96	0314-62408.1	≤ 0.23
HEP Optimo L Solar 30-10.0 G180	1¼"	2"	-	180	230	15 ... 195	0.090 ... 0.90	5.0	0314-64210.1	≤ 0.23
HEP Optimo L Solar 32-8.0 G220	-	-	DN 32	220	230	15 ... 180	0.090 ... 0.90	6.135	0314-94208.1	≤ 0.23
HEP Optimo L Solar 32-10.0 G220	-	-	DN 32	220	230	15 ... 195	0.090 ... 0.90	6.135	0314-94210.1	≤ 0.23
HEP Optimo L Solar 40-8.0 G220	-	-	DN 40	220	230	15 ... 180	0.090 ... 0.90	6.135	0315-94208.1	≤ 0.23
HEP Optimo L Solar 40-10.0 G220	-	-	DN 40	220	230	15 ... 195	0.090 ... 0.90	6.135	0315-94210.1	≤ 0.23

### Proportional pressure

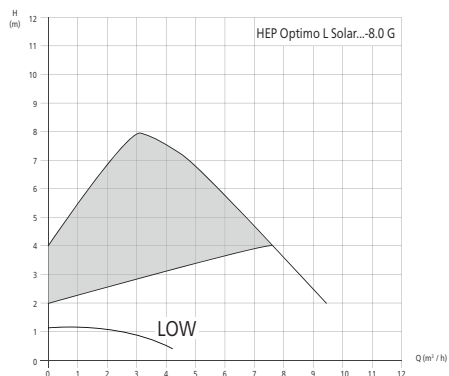

### Constant pressure

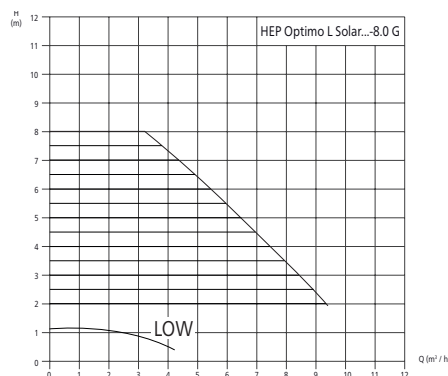

### Fixed rpm

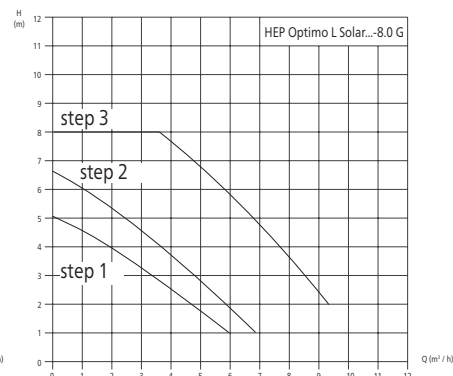

### Proportional pressure

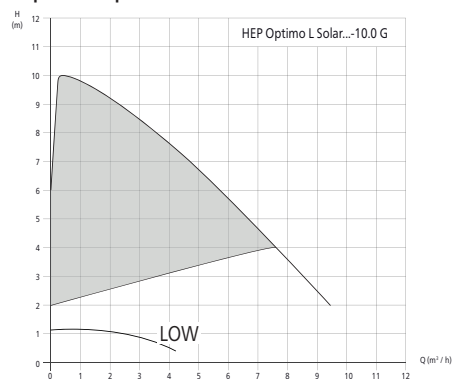

### Constant pressure

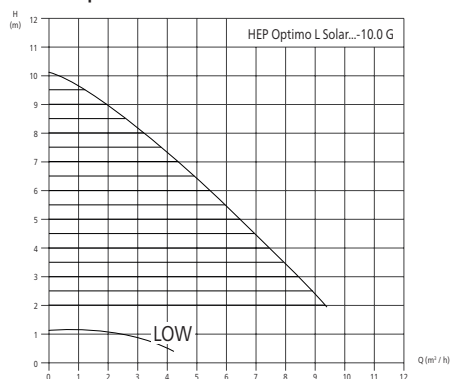

### Fixed rpm

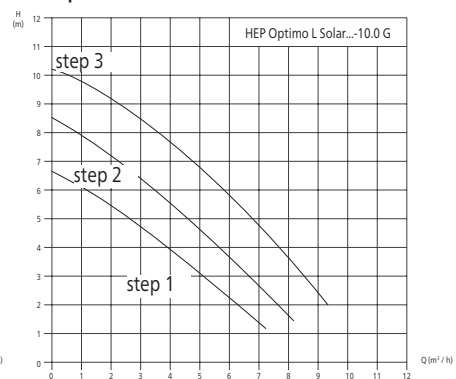

## Dimensions

Type	L1	L2	L3	L4
HEP Optimo L (thread)	180	267	178	225
HEP Optimo L (flange)	220	267	177.5	245

## Dimension illustration

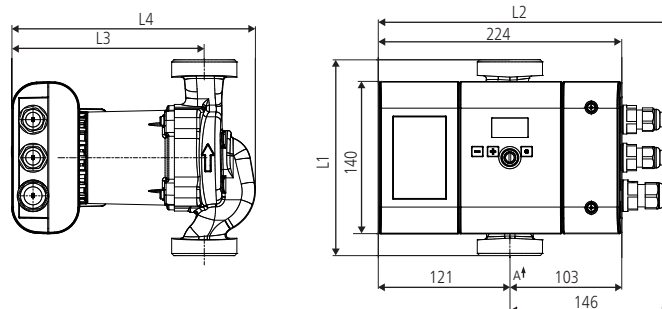



# HEP BB2

Babelbox BB2 and HEP PWM , S3 product group



### Technical data

Supply voltage:	230 V
Power input:	0.25 W
Signal input leading edge:	0-230 V
Signal input trailing edge:	0-230 V
Signal input wave packet:	0-230 V, 50 Hz
Signal input power consumption:	1.5 mA
PWM output:	12 V DC, 15 mA
Frequency:	1000 Hz
Ambient temperature:	0 °C to +70 °C
Cable connection input:	3 x M16
Dimensions:	115 x 117 x 50 mm
Weight:	0.3 kg

### Use

The Babelbox BB2 is designed for use in heating systems in which an on-site controller pulses a standard pump via the power line and this pump is to be replaced by a high-efficiency pump. High-efficiency pumps do not react to a pulsed power line and therefore cannot simply substitute for a standard pump. Interposing the Babelbox BB2 solves this issue while retaining the control functions of the system.

### Mode of operation

The BB2 automatically detects if an on-site controller is pulsing the power line via a wave packet or is outputting leading or trailing edge voltage. The BB2 converts this into a PWM signal which is identified by the Halm PWM pump. Just like the standard pump previously, its power is also then controlled. An integrated LED shows the presence of voltage from the on-site controller.

### Main areas of use

All applications in which a standard pump controlled externally by the power line is to be replaced by a high-efficiency pump.

- Return flow boost
- Solar installation
- Differential temperature controlled underfloor heating
- Storage charging circuit
- Freshwater station (suitability should be checked with the manufacturer due to the highly sensitive controlled system)

### Installation

Stable cable bushings and elevator terminals enable easy installation. The BB2 must be connected to 230 V voltage, with the PWM pump and the pulsed power line. Fully automatic detection of the input signal means no further settings need be adjusted.

### Motor (high efficient ECM technology)

Power supply nominal:	200-230 V, 50-60 Hz
Power consumption:	Version 4 m (4- 25 W); Version 7 m (4-70 W)
Power consumption stand-by PWM:	0.8 W

### PWM connection

PWM input:	
Frequency f nominal:	100-2000 Hz
Voltage U nominal:	5-24 V
Power PWM to 12 V:	max. 10 mA
Power PWM to 24 V:	max. 20 mA
Insulation voltage optocoupler:	5300 VRMS
	$(T_{in} / T_{pwm}) \times 100$

### Standards

8/37/EG, 2006/95/EG, 2004/108/EG  
 EN 60335-1, EN 60335-2-51,  
 EN 55014-1:2006+A1:2009,  
 EN 55014-2:1997+A1.2001+A2:2008  
 EN 61000-6:2007, EN 61000-6-3:2007,  
 EN 50366, EN 61000-3-2, EN 61000-3-3,  
 EN 55014-1, EN 55014-2

### The Babelbox BB2 solution



It was previously not possible to replace standard heating pumps driven by wave packet, leading or trailing edge control with high-efficiency pumps. For the first time, this can now be done with the Babelbox BB2.

### Fully automatic signal detection



Typical high-efficiency pumps require a 230 V constant voltage supply. If, however, a high-efficiency pump is connected to a variable power voltage supply (solar controller, freshwater station controller, charging controller etc.), it reacts neither to a wave packet nor leading edge control as desired. This is where the Babelbox BB2 from Halm comes in. It independently and fully automatically detects which signal is being output by the controller of the standard pump and converts it into a PWM signal which can be understood by the high-efficiency pump, controlling the latter in just the same way as the previously installed standard pump. The voltage supply for the high-efficiency pump itself comes from a separate 230 V connection.



### Technical data

Type	Connection pipe	Threaded connection	Installation length (mm)	P1 (W)	In (A)	Weight (kg)	Product no.
HEP BB2 25-4.0 G180	1"	1 1/2"	180	4 ... 25	... 0.3	3.0	0323-34204.7
HEP BB2 25-7.0 G180	1"	1 1/2"	180	4 ... 66	... 0.6	3.0	0323-34207.7
HEP BB2 30-4.0 G180	1 1/4"	2"	180	4 ... 25	...0.3	3.1	0324-34204.7
HEP BB2 30-7.0 G180	1 1/4"	2"	180	4 ... 66	...0.6	3.1	0324-34207.7
HEP BB2 15-4.0 G130	1/2"	1"	130	4 ... 25	... 0.3	3.0	0321-34004.7
HEP BB2 15-7.0 G130	1/2"	1"	130	4 ... 66	... 0.6	3.0	0321-34007.7
HEP BB2 25-4.0 G130	1"	1 1/2"	130	4 ... 25	... 0.3	3.0	0323-34004.7
HEP BB2 25-7.0 G130	1"	1 1/2"	130	4 ... 66	... 0.6	3.0	0323-34007.7

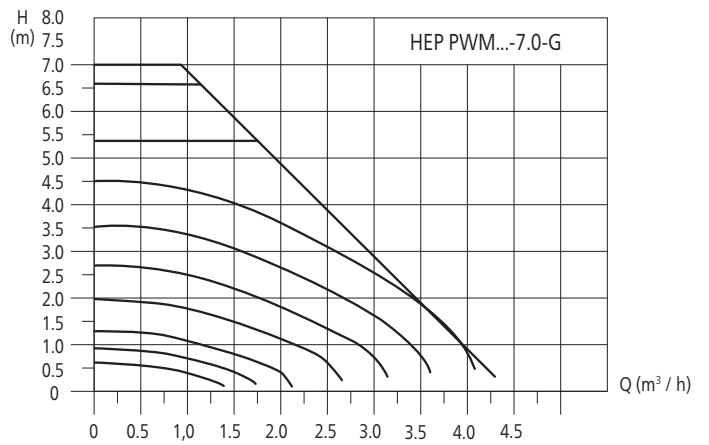
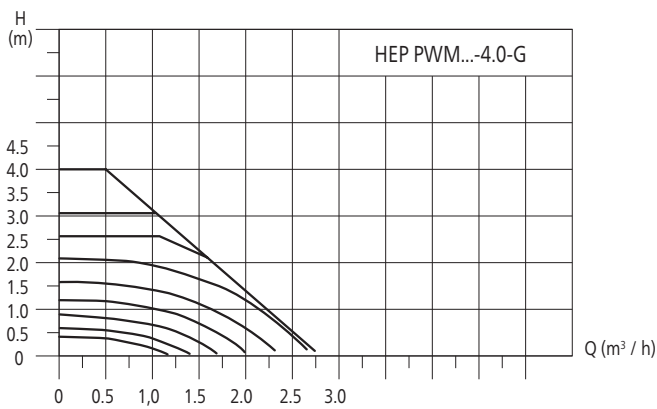



# High efficiency pumps with LED display, electronically controlled and protected against condensation

## HEP Optimo Geo series, G1 product group



**Insulation shell**  
With installation length  
180 mm included  
in delivery.

**BEST  
in class**

valid for all Halm 4 m  
High efficiency pumps



### Technical data

Rate of flow:	up to 3.2 m <sup>3</sup> /h
Pressure head:	4 m/6 m
Control range:	4-23 W/4-50 W
Media temperature:	-15 °C to +95 °C
Installation length:	130 and 180 mm
Threaded connection:	1", 1½" and 2"
Protection class:	IP 42
Insulation class:	F
Nominal pressure:	PN 10
Control:	Δpc + Δpv + fixed rpm
EEL:	≤ 0.20 HEP Optimo Geo XX-4.0 GXXX ≤ 0.23 HEP Optimo Geo XX-6.0 GXXX

### Product features

- manual start-up feature
- smooth running
- very low energy consumption
- integrated night economy feature
- air-vent screw
- LED display
- convenient operation
- space-saving axially integrated terminal box
- automatic adjustment to pressure conditions
- cataphoretic coated pump housing
- pre-mounted, screwable angle entry-plug
- compact design

### Use

The electronically controlled HEP Optimo Geo high efficiency wet rotor circulators with LED display and permanent magnet technology are designed for use in heating and cold water circulation systems with variable or constant rate of flow. The motor integrity offers a sealed winding protection from ingress of condensation. The cataphoretic coated pump housing is stainless.

### Mode of operation Δp control

When thermostatic valves in systems with a long main supply heating pipe (likely for radiator systems) close, the total flow drops. This results in lower pipe resistance in this main pipe, which means the pump has to create lower head. Using proportional pressure mode PP (L) is the best setting for such heating systems, as here the pump decreases head at lower flow.

If the main supply heating pipe has not to be taken into consideration, because it is short or has its own pump (likely for underfloor heating systems with in mixing units integrated pumps) or heating pumps, best mode to go with is constant pressure mode CP (E). In such heating systems, it is important always to have constant pressure for the radiators or ufh-circuits, as the pressure loss in the main pipe is not considered and all other consumers are installed in parallel, which does not influence the maximum pressure loss.

### Main areas of use

Heating, air-conditioning and industry systems as

- dual pipe system
- underfloor heating
- boiler/primary circuit
- storage charging circuit
- solar systems and heating pumps

### Materials

Component	Material	Material no.
Pump housing	Grey-cast iron	0.6020
Impeller	Polyamide (PA - GF 35)	
Shaft	Ceramic	
Bearing	Ceramic	
Bearing plate	Stainless steel	1.4301
Can	Stainless steel	1.4301

### Flow media

- heating water as per VDI 2035
- pure, thin, non-aggressive and non-explosive, mineral oil-free media without solid or long-fibre components
- media with a max. viscosity of 10 mm<sup>2</sup>/s
- operating data must be checked above 20 % glycol

### Temperature range

Ambient temperature:	0 °C to +40 °C
Temperature class:	TF 95
Media temperature:	-15 °C to +95 °C

### Ambient temperature

To avoid condensation forming in the terminal box and stator, the media temperature must always be the same or higher than the ambient temperature.

Ambient temp.	Media temp. min.	Media temp. max.
0	2	95
10	10	95
20	20	95
30	30	95
35	35	90
40	40	70

### Motor protection

External motor protection is not required.

### Integrated night economy feature

When the automatic night economy feature is activated, the circulation pump switches between normal mode and economy mode (characteristic curve MIN). The flow temperature is detected by a temperature sensor, the pump reacts accordingly. For this, it is necessary for the circulation pump to be installed in flow.

### Minimum inflow pressure

Please determine the minimum inflow pressure for corresponding temperature from the following table.

Media temperature	< 75 °C	> 90 °C
Minimum inflow pressure	0.05 bar	0.28 bar

### Sound pressure level

The sound pressure level is < 45 dB (A)

### Choice of control characteristic

You can set 3 different control modes via the potentiometer on the axial terminal box. Proportional pressure (L), fixed speed (M) and constant pressure (E) can be adjusted continuously variable. The display indicates power consumption in [W] watts. Once the potentiometer is turned, the display first indicates mode of operation (PP, SC, CP), then value of set head in [m] meters. At the factory setting the potentiometer is in mode PP.





### Technical data

Type	Connection pipe	Threaded connection	Installation length (mm)	Voltage (V)	P1 (W)	In (A)	Weight (kg)	Product no.	EEl
HEP Optimo Geo 25-4.0 G180	1"	1½"	180	230	4 ... 23	... 0.30	2.7	0323-34204.8	≤ 0.20
HEP Optimo Geo 25-6.0 G180	1"	1½"	180	230	4 ... 50	... 0.46	2.7	0323-34206.8	≤ 0.23
HEP Optimo Geo 30-4.0 G180	1¼"	2"	180	230	4 ... 23	... 0.30	2.8	0324-34204.8	≤ 0.20
HEP Optimo Geo 30-6.0 G180	1¼"	2"	180	230	4 ... 50	... 0.46	2.8	0324-34206.8	≤ 0.23
HEP Optimo Geo 15-4.0 G130	½"	1"	130	230	4 ... 23	... 0.30	2.7	0321-34004.8	≤ 0.20
HEP Optimo Geo 15-6.0 G130	½"	1"	130	230	4 ... 50	... 0.46	2.7	0321-34006.8	≤ 0.23
HEP Optimo Geo 20-4.0 G130	¾"	1¼"	130	230	4 ... 23	... 0.30	2.7	0322-34004.8	≤ 0.20
HEP Optimo Geo 20-6.0 G130	¾"	1¼"	130	230	4 ... 50	... 0.46	2.7	0322-34006.8	≤ 0.23
HEP Optimo Geo 25-4.0 G130	1"	1½"	130	230	4 ... 23	... 0.30	2.7	0323-34004.8	≤ 0.20
HEP Optimo Geo 25-6.0 G130	1"	1½"	130	230	4 ... 50	... 0.46	2.7	0323-34006.8	≤ 0.23

### Constant pressure

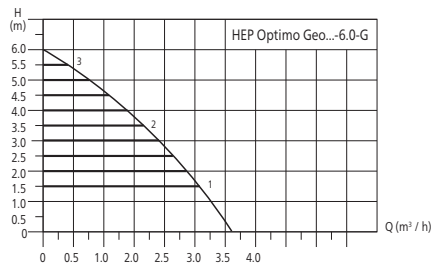
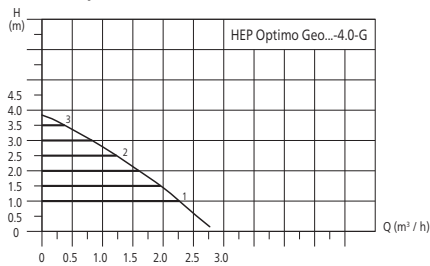

### Proportional pressure

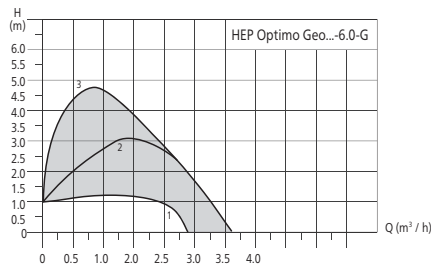
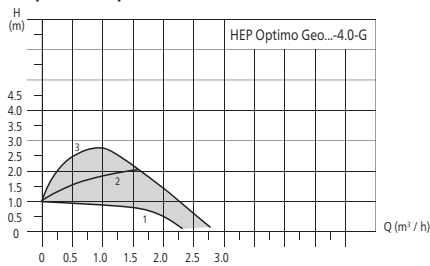

### Fixed rpm

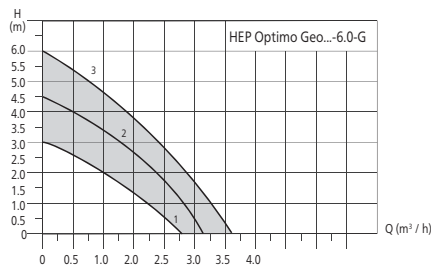
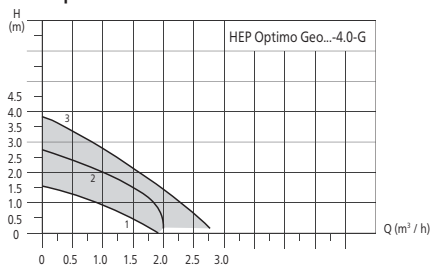

### Dimensions

Type	L1	L2	L3	L4
HEP Optimo Geo	130/180	98	127	163

### Dimension illustration

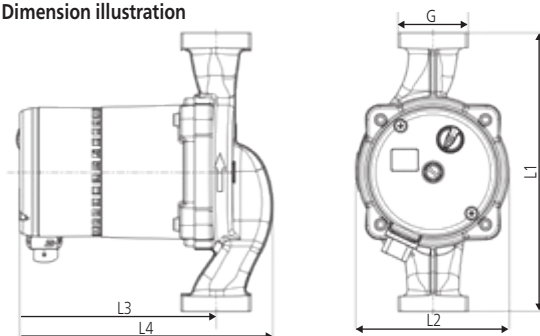



# High efficiency pumps with LCD display, electronically controlled and protected against condensation

## HEP Optimo L Geo series, G2 product group



### Technical data

Rate of flow:	up to 10 m <sup>3</sup> /h
Pressure head:	8 m/10 m
Control range:	15-180 W/15-195 W
Media temperature:	-15 °C to +95 °C
Installation length:	180 mm (thread)/220 mm (flange)
Threaded connection:	1½" and 2" (thread)/DN 32 and DN 40 (flange)
Protection class:	IP 42
Insulation class:	F
Nominal pressure:	PN 10
EEL:	≤ 0.23 HEP Optimo L XX-8.0 G ≤ 0.23 HEP Optimo L XX-10.0 G

### Control:

Internal:	Δpc + Δpv + fixed rpm
External:	<ul style="list-style-type: none"> <li>digital: PWM (characteristic lines for heating and solar per VDMA device paper 24224) frequency f nominal: 100-1000 Hz voltage U nominal: 5-15 V power I: 10 mA</li> <li>analogue: 0-10 V with cable break detection power I: 1 mA impedance: 10 kOhm</li> </ul>

Omnibus fault message: Selector switch, potential-free, power max. 2 A/240 VAC  
Power supply for external unit: Voltage DC 12 V, power max. 100 mA

### Product features

- LCD display
- manual start-up feature
- smooth running
- very low energy consumption
- air-vent screw
- collective fault signal
- convenient operation
- axially integrated terminal box
- automatic adjustment to pressure conditions
- cathoretic coated pump housing

### Use

The electronically controlled HEP Optimo L Geo high efficiency wet rotor circulators with LCD display and permanent magnet technology are designed for use in heating systems with variable or constant rate of flow. The cathoretic coated pump housing is stainless.

### Main areas of use

Heating, air-conditioning and industry systems as

- dual pipe system
- single pipe system
- underfloor heating
- boiler/primary circuit
- storage charging circuit
- solar systems and heating pumps

### Controls Function

You can make adjustments with the integrated control keys at the front. The LCD display shows the total electrical input power as a numeric value in [W] watts. Different icons at the top of the display show the function, setting and the modes of operation.

### Materials

Component	Material	Material No.
Pump body	Grey-cast iron	0.6020
Impeller	Polyamide (PA - GF 35)	
Shaft	Ceramic	
Bearing	Ceramic	
Bearing plate	Stainless steel	1.4301
Can	Stainless steel	1.4301

### Flow media

- heating water as per VDI 2035
- pure, thin, non-aggressive and non-explosive, mineral oil-free media without solid or long-fibre components
- media with a max. viscosity of 10 mm<sup>2</sup>/s
- operating data must be checked above 20 % glycol

### Temperature range

Ambient temperature:	0 °C to +40 °C
Temperature class:	TF 95
Media temperature:	-15 °C to +95 °C

### Ambient temperature

To avoid condensation forming in the terminal box and stator, the media temperature must always be the same or higher than the ambient temperature.

Ambient temp.	Media temp. min.	Media temp. max.
0	2	95
10	10	95
20	20	95
30	30	95
35	35	90
40	40	70

### Motor protection

External motor protection is not required.

### Minimum inflow pressure

Please determine the minimum inflow pressure for corresponding temperature from the following table.

Media temperature	< 75 °C	> 90 °C
Minimum inflow pressure	0.05 bar	0.45 bar

### Sound pressure level

The sound pressure level is < 45 dB (A)



# High efficiency pumps with LCD display, electronically controlled and protected against condensation

HEP Optimo L Geo series, G2 product group



## Technical data

Type	Connection pipe	Threaded connection	Flange	Installation length (mm)	Voltage (V)	P1 (W)	In (A)	Weight (kg)	Product no.	EEL
HEP Optimo L Geo 25-8.0 G180	1"	1½"	-	180	230	15 ... 180	0.090 ... 0.90	5.96	0323-62408.8	≤ 0.23
HEP Optimo L Geo 25-10.0 G180	1"	1½"	-	180	230	15 ... 195	0.090 ... 0.90	5.96	0323-64210.8	≤ 0.23
HEP Optimo L Geo 30-8.0 G180	1¼"	2"	-	180	230	15 ... 180	0.090 ... 0.90	5.96	0324-62408.8	≤ 0.23
HEP Optimo L Geo 30-10.0 G180	1¼"	2"	-	180	230	15 ... 195	0.090 ... 0.90	5.96	0324-64210.8	≤ 0.23
HEP Optimo L Geo 32-8.0 G220	-	-	DN 32	220	230	15 ... 180	0.090 ... 0.90	6.135	0324-94208.8	≤ 0.23
HEP Optimo L Geo 32-10.0 G220	-	-	DN 32	220	230	15 ... 195	0.090 ... 0.90	6.135	0324-94210.8	≤ 0.23
HEP Optimo L Geo 40-8.0 G220	-	-	DN 40	220	230	15 ... 180	0.090 ... 0.90	6.135	0325-94208.8	≤ 0.23
HEP Optimo L Geo 40-10.0 G220	-	-	DN 40	220	230	15 ... 195	0.090 ... 0.90	6.135	0325-94210.8	≤ 0.23

### Proportional pressure

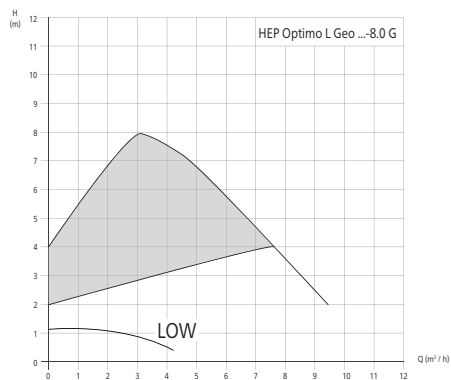

### Constant pressure

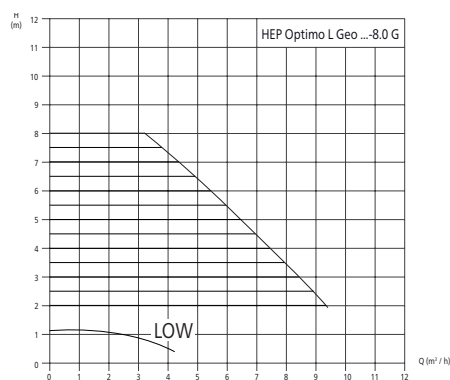

### Fixed rpm

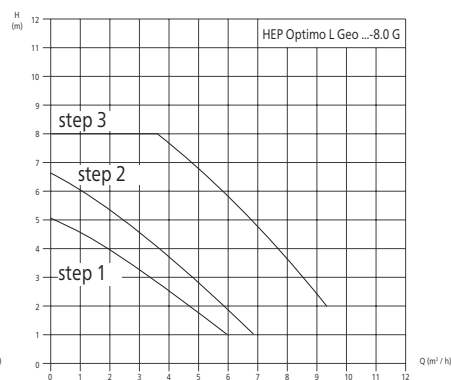

### Proportional pressure

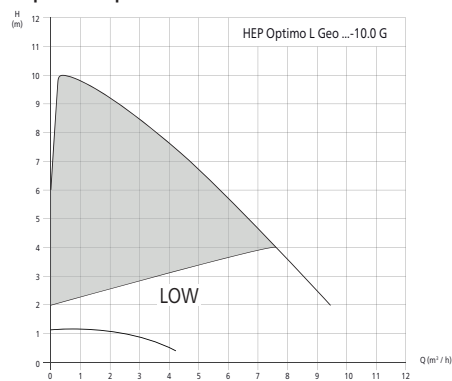

### Constant pressure

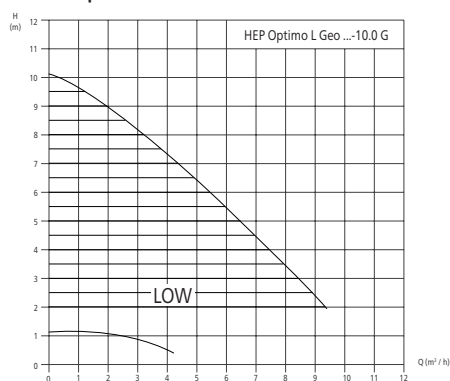

### Fixed rpm

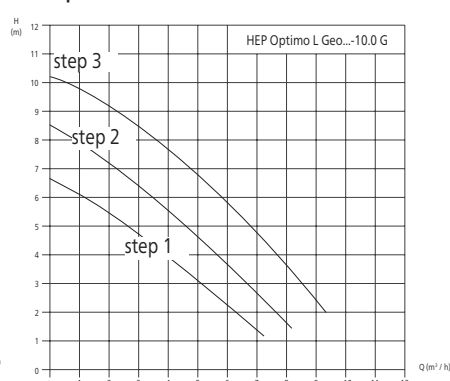

## Dimensions

Type	L1	L2	L3	L4
HEP Optimo L (thread)	180	267	178	225
HEP Optimo L (flange)	220	267	177.5	245

## Dimension illustration

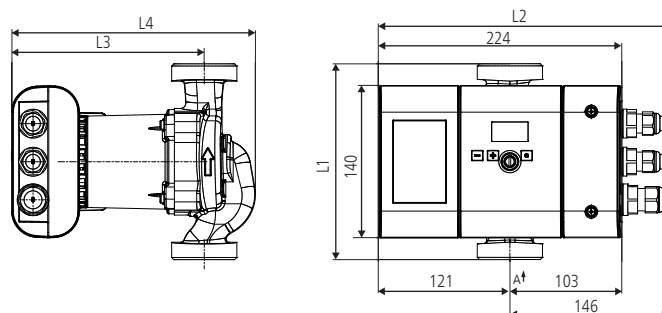

# Condensate pump for gas condensing boilers up to 400 kW

## Lift series, K1 product group



### Technical data

Electrical connection:	230 V, 50/60 Hz
Input power:	65 W
Alarm contact:	max. 230 V, 8 A (resistive load), NO normally open/NC normally closed
Protection class:	IP 55
Medium:	condensate pH $\geq 3$ , temperature 70 °C max
Rate of flow:	max. 350 l/h
Pressure head:	max. 4 m
Noise level:	max. 29 dB [A]
Dimensions:	185 x 85 x 100 mm (L x W x H)
Condensate supply:	$\varnothing$ 24 mm
Condensate suction head:	83 mm
Tank:	ABS plastic, max. 0.5 l/0.13 Gal
Condensation drain:	nozzles for hose connection $\varnothing$ 8 x 2 mm
Discharge hose:	included in the scope of delivery
Weight:	1.5 kg

### Product features

- fully automatic condensate pump delivered completely ready for connection
- extremely quiet and vibration free
- very compact and space-saving construction
- fully encapsulated pump unit (IP 55) resistant to water jets from any direction
- pump unit also suitable for use in external tank (tank height min. 62 mm, max. 70 mm)
- integrated check valve for discharge hose
- condensation discharge hose (6 m,  $\varnothing$  8 x 2 mm) included in delivery
- pre-mounted power cable (1.6 m) incl. shockproof plug
- overflow protection through separate float
- potential-free alarm connection (NO normally open/NC normally closed)
- pre-mounted alarm cable (0.9 m) incl. wall mounting

### Delivery program

Type	Max pressure head	Max rate of flow	For condensing boilers up to	Remarks	Product no.
Lift	4 m	350 l/h	400 kW	incl. pressure hose (6 m, $\varnothing$ 8 x 2 mm)	0341-00400

### Use

The Lift condensate pump is a fully automatic unit for the extraction of condensate, produced in gas/oil condensing boilers, air-conditioning systems, refrigerated counters and dehumidifiers incl. collection tank. It can be used anywhere where a condensate disposal through gravity is not possible or where there is no direct drain. The Lift condensate pump is designed for gas condensing boilers up to 400 kW.

The housing is made from ABS plastic and is therefore resistant to acidic condensate (pH  $\geq 3$ ). For very acidic condensate (pH  $< 3$ ), for the use of low-sulfur heating oil and for installations/systems with over 200 kW, it is compulsory according to ATV-DVWK-A 251 in Germany to install a neutralization system (see condensate pump Lift NT25 resp. additional neutralization tank NT50). Complementary municipal or other national regulations must be observed where necessary.

For the use in oil condensing boilers we recommend the additional use of an extension kit with activated carbon (see accessories for condensate pumps).

### Main areas of use

- gas condensing boilers
- oil condensing boilers
- air-conditioning systems
- refrigerators, refrigerated cabinets, refrigerated counters\*
- dehumidifiers, evaporators
- \*) not suitable for splash water

### Flow media

- Condensates with a pH  $\geq 3$  and a 70 °C max temperature.
- Condensates with a pH over 3 have to be neutralized.
- Condensates with oil residues from oil condensing boilers must be cleaned with activated carbon (extension kit) if necessary.

### Temperature range

Media temperature:	+2 °C to +70 °C
Ambient temperature:	+5 °C to +45 °C

### Switching points

Alarm max.	55 mm
Start	52 +/- 1 mm
Stop	24 +/- 1 mm

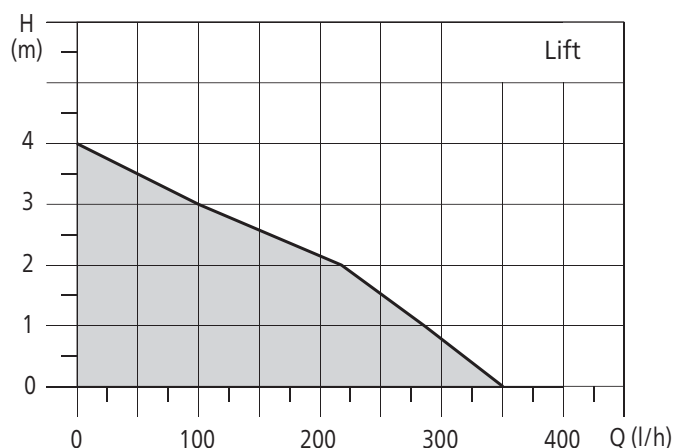

# Condensate pump for gas condensing boilers up to 300 kW

Lift Basic series, K1 product group



## Technical data

Electrical connection:	230 V, 50/60 Hz
Input power:	65 W
Alarm contact:	max. 230 V, 8 A (resistive load), NO normally open/NC normally closed
Protection class:	IP 20
Medium:	condensate pH $\geq 3$ , temperature 70 °C max
Rate of flow:	max. 200 l/h
Pressure head:	max. 4 m
Noise level:	max. 33 dB [A]
Dimensions:	200 x 105 x 160 mm (L x W x H)
Condensate supply:	$\varnothing$ 24 mm
Condensate suction head:	77 mm
Tank:	ABS plastic, max. 1.0 l/0.26 Gal
Condensation drain:	nozzles for hose connection $\varnothing$ 8 x 2 mm
Discharge hose:	included in the scope of delivery
Weight:	1.6 kg

## Product features

- fully automatic condensate pump delivered completely ready for connection
- extremely quiet
- space-saving construction
- housing made from ABS plastics is resistant to condensate
- integrated check valve for discharge hose
- condensation discharge hose (6 m,  $\varnothing$  8 x 2 mm) included in delivery
- pre-mounted power cable (1.6 m) incl. shockproof plug
- overflow protection through separate float
- potential-free alarm connection (NO normally open/NC normally closed)
- pre-mounted alarm cable (0.9 m) incl. wall mounting

## Use

The Lift Basic condensate pump is a fully automatic unit for the extraction of condensate, produced in gas/oil condensing boilers, air-conditioning systems, refrigerated counters and dehumidifiers incl. collection tank. It can be used anywhere where a condensate disposal through gravity is not possible or where there is no direct drain. The Lift Basic condensate pump is designed for gas condensing boilers up to 300 kW.

The housing is made from ABS plastic and is therefore resistant to acidic condensate (pH  $\geq 3$ ). For very acidic condensate (pH  $< 3$ ), for the use of low-sulfur heating oil and for installations/systems with over 200 kW, it is compulsory according to ATV-DVWK-A 251 in Germany to install a neutralization system (see condensate pump Lift NT25 resp. additional neutralization tank NT50). Complementary municipal or other national regulations must be observed where necessary.

For the use in oil condensing boilers we recommend the additional use of an extension kit with activated carbon (see accessories for condensate pumps).

## Main areas of use

- gas condensing boilers
- oil condensing boilers
- air-conditioning systems
- refrigerators, refrigerated cabinets, refrigerated counters\*
- dehumidifiers, evaporators
- \*) not suitable for splash water

## Flow media

- Condensates with a pH  $\geq 3$  and a 70 °C max temperature.
- Condensates with a pH over 3 have to be neutralized.
- Condensates with oil residues from oil condensing boilers must be cleaned with activated carbon (extension kit) if necessary.

## Temperature range

Media temperature:	+2 °C to +70 °C
Ambient temperature:	+5 °C to +45 °C

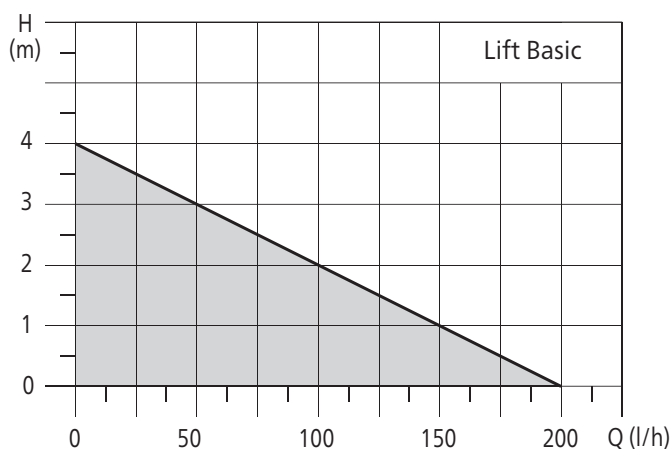

## Delivery program

Type	Max pressure head	Max rate of flow	For condensing boilers up to	Remarks	Product no.
Lift Basic	4 m	200 l/h	300 kW	incl. pressure hose (6 m, $\varnothing$ 8 x 2 mm)	0341-00300

# Condensate pump for oil condensing boilers with neutralization tank

Lift NT25 series, K1 product group



## Technical data

Electrical connection:	230 V, 50/60 Hz
Input power:	40 W
Alarm contact:	max. 230 V, 8 A (resistive load), NO normally open/NC normally closed
Protection class:	IP 20
Medium:	condensate pH $\geq 3$ , temperature 70 °C max
Rate of flow:	max. 14 l/h
Pressure head:	max. 10 m
Noise level:	max. 36 dB [A]
Dimensions:	244 x 174 x 261 mm (L x W x H)
Condensate supply:	$\varnothing$ 40 mm
Condensate suction head:	200 mm
Neutralization tank:	ABS plastic, 6.0 l/1.59 Gal, incl. neutralization granulate (1 kg)
Condensation drain:	nozzles for hose connection $\varnothing$ 8 x 2 mm
Weight:	2.7 kg

## Product features

- fully automatic condensate pump delivered completely ready for connection, incl. neutralization tank
- noise-reducing electronic controls with follow-up time to reduce switching frequency
- space-saving construction
- integrated collection/neutralization tank, incl. first fill with neutralization granulate (1 kg) – sufficient for about 12 months for systems up to 25 kW
- upstream suction filter as well as check valve for discharge hose
- connection for discharge hose ( $\varnothing$  6 x 1.5 mm)
- pre-mounted power cable (1.0 m) incl. shockproof plug
- overflow protection through separate float
- potential-free alarm connection (NO normally open/NC normally closed)

## Use

The Lift NT25 condensate pump is a fully automatic unit for the extraction of condensate, produced in gas/oil condensing boilers, air-conditioning systems, refrigerated counters and dehumidifiers incl. collection/neutralization tank. It can be used anywhere where a condensate disposal through gravity is not possible or where there is no direct drain. The Lift NT25 condensate pump is designed for gas and oil condensing boilers up to 25 kW. It is extensible for systems up to 100 kW with additional accessories NB2 and NT50.

The housing is made from ABS plastic and is therefore resistant to acidic condensate (pH  $\geq 3$ ).

For the use in oil condensing boilers we recommend the additional use of an extension kit with activated carbon (see accessories for condensate pumps).

## Schematic sketch Lift NT25

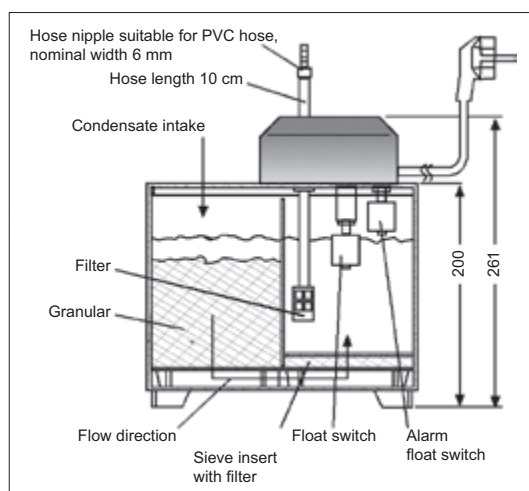

## Main areas of use

- gas condensing boilers
- oil condensing boilers

## Flow media

- Condensates produced in gas and oil condensing boilers with a 70 °C max temperature.
- Condensates with oil residues from oil condensing boilers must be cleaned with activated carbon (extension kit) if necessary.

## Temperature range

Media temperature:	+2 °C to +70 °C
Ambient temperature:	+5 °C to +45 °C

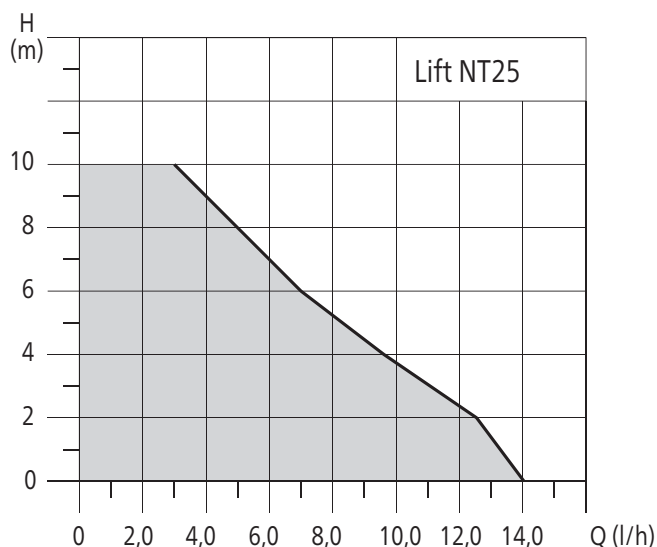

# Condensate pump for oil condensing boilers with neutralization tank

Lift NT25 series, K1 product group



## Delivery program

Type	Max pressure head	Max rate of flow	For condensing boilers up to	Remarks	Product no.
Lift NT25	10 m	14 l/h	25 kW	incl. neutralization tank incl. first fill with neutralization granulate	0341-00025

## Connection alarm cable

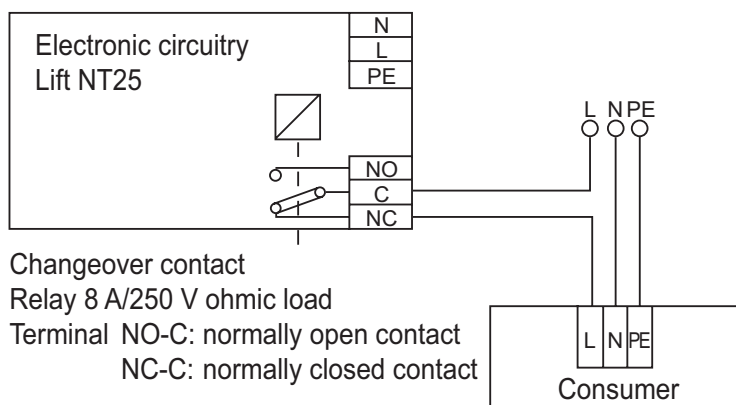

## Connection example for potential-free contact

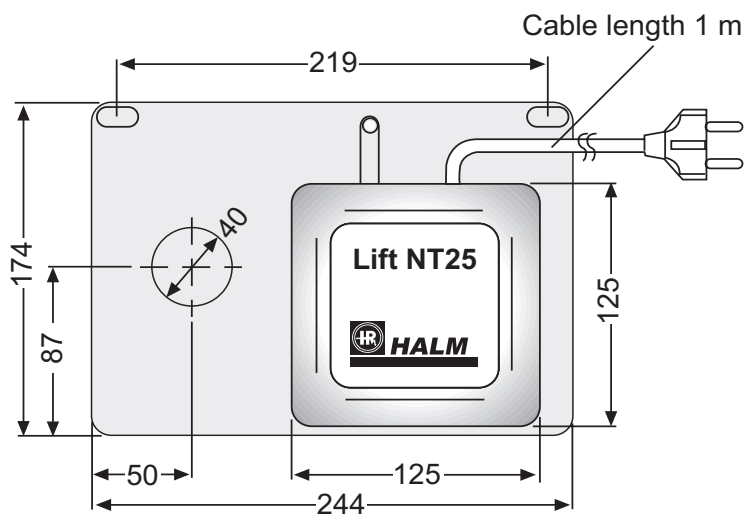



# Accessories

## Z1 product group

### Screw connections

Type	Product no.	Description
Grey cast iron connection G 1"	4152-0001.1	1 set c.i. connection Rp 1/2" x G 1"
Grey cast iron connection G 1 1/4"	4152-0001.2	1 set c.i. connection
Grey cast iron connection G 1 1/2"	4152-0001.3	1 set c.i. connection Rp 1" x G 1 1/2"
Grey cast iron connection G 2"	4152-0001.4	1 set c.i. connection Rp 1 1/4" x G 2"
Brass connection G 1"	4152-0005.1	1 set brass connection Rp 1/2" x G 1"
Brass connection G 1 1/4"	4152-0005.2	1 set brass connection Rp 3/4" x G 1 1/4"
Brass connection G 1 1/2"	4152-0005.3	1 set brass connection Rp 1" x G 1 1/2"

### Plug



Type	Product no.	Description
Plug complete	3219-2205-01	Plug for series HEP complete incl. Socket on motor side
Socket only	3219-2204	Socket on motor side for plug for series HEP

### Insulation shell



Type	Product no.	Description
Insulation shell	4152-0100	Insulation shell (EPP) for series HEP installation length 180 mm

Further accessories on request.



Sample



### Maintenance kit for Lift NT25

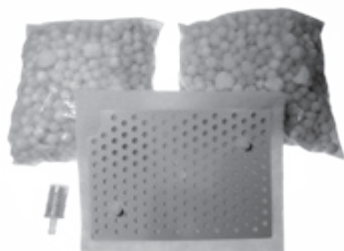

Type	Product no.	Description
Maintenance kit for Lift NT25	4152-0107	Maintenance kit for Lift NT25 for the yearly maintenance consisting of neutralization granulate (2 kg), replacement filter sieve with fleece, replacement filter element for suction filters.

### Extension kit oil condensing boilers

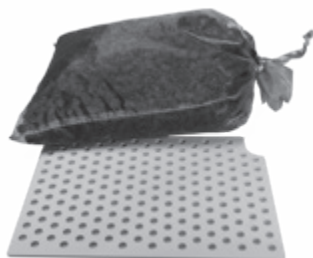

Type	Product no.	Description
Extension kit oil condensing boilers	4152-0108	Extension kit for Lift NT25 for oil condensing boilers consisting of activated carbon filter and sieve.

### NT50



Type	Product no.	Description
NT50	4152-0109	Additional collection/neutralization tank with granulate (2 x 2 kg) for neutralization capacity 50 kW, filter sieves (2x) and connection/nozzle for the connection to the Lift NT25. Condensate supply opening Ø40 mm/condensate supply height 200 mm.

### NG2

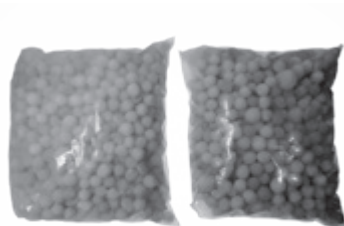

Type	Product no.	Description
NG2	4152-0110	Refill pack neutralization granulate (2 kg)

### Alarm plus



Type	Product no.	Description
Alarm plus	4152-0111	Audio and visual fault indicator for the alarm output of the condensate pump (230 V, 50/60 Hz) for the connection to the condensate pump with alarm relay output, 56 x 88 x 51 mm (L x W x H), input power 1.9 W, IP 20, ambient temperature +5 °C to +50 °C.

Further accessories and spare parts on request.



Product no. 4308-0126-EN-EU Version 1.0 (11/2015)

Your representative:



Halm Pumpen + Motoren GmbH

Silcherstrasse 54-58  
73666 Baltmannsweiler, Germany

Postfach 69  
73664 Baltmannsweiler, Germany

Tel.: +49 7153 9202-0  
Fax: +49 7153 49701

E-Mail: [info@halm.info](mailto:info@halm.info)  
[www.halm-pumps.de](http://www.halm-pumps.de)



**BEST**  
in class

